

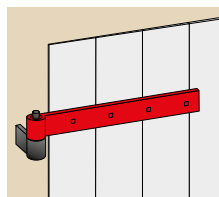

L'EXTÉRIEUR DE L'HABITAT

LE VOLET BOIS

LE VOLET BOIS



Penture bout droit

| Code | Gencod | | D | L | I | Ep. | Type packaging | | |
|-------------|---------------|---------|----|------|----|-----|----------------|----|--|
| 30x4 | | | | | | | | | |
| 0662601 | 3308180035698 | | 14 | 300 | 30 | 4 | Vrac gencodé | 5 | |
| 0662701 | 3308180035704 | | 14 | 400 | 30 | 4 | Vrac gencodé | 5 | |
| 0662801 | 3308180035711 | | 14 | 500 | 30 | 4 | Vrac gencodé | 5 | |
| 0662603 | 3308186626036 | Z.BLANC | 14 | 300 | 30 | 4 | Vrac gencodé | 5 | |
| 0662703 | 3308186627033 | Z.BLANC | 14 | 400 | 30 | 4 | Vrac gencodé | 5 | |
| 0662803 | 3308180038750 | Z.BLANC | 14 | 500 | 30 | 4 | Vrac gencodé | 5 | |
| 35x4 | | | | | | | | | |
| 0663001 | 3308180035735 | | 14 | 300 | 35 | 4 | Vrac gencodé | 5 | |
| 0663101 | 3308180035742 | | 14 | 400 | 35 | 4 | Vrac gencodé | 5 | |
| 0663201 | 3308180035759 | | 14 | 500 | 35 | 4 | Vrac gencodé | 5 | |
| 0663401 | 3308180035766 | | 14 | 600 | 35 | 4 | Vrac gencodé | 5 | |
| 0663601 | 3308180035773 | | 14 | 700 | 35 | 4 | Vrac gencodé | 5 | |
| 0663701 | 3308180035780 | | 14 | 800 | 35 | 4 | Vrac gencodé | 5 | |
| 0663003 | 3308180037265 | Z.BLANC | 14 | 300 | 35 | 4 | Vrac gencodé | 5 | |
| 0663103 | 3308180038408 | Z.BLANC | 14 | 400 | 35 | 4 | Vrac gencodé | 5 | |
| 0663203 | 3308186632037 | Z.BLANC | 14 | 500 | 35 | 4 | Vrac gencodé | 5 | |
| 0663403 | 3308186634031 | Z.BLANC | 14 | 600 | 35 | 4 | Vrac gencodé | 5 | |
| 0663603 | 3308186636035 | Z.BLANC | 14 | 700 | 35 | 4 | Vrac gencodé | 5 | |
| 0663703 | 3308186637032 | Z.BLANC | 14 | 800 | 35 | 4 | Vrac gencodé | 5 | |
| 0943201 | 3308189432016 | | 14 | 300 | 35 | 4 | | 20 | |
| 0943301 | 3308189433013 | | 14 | 400 | 35 | 4 | | 20 | |
| 0943401 | 3308189434010 | | 14 | 500 | 35 | 4 | | 10 | |
| 0943501 | 3308189435017 | | 14 | 600 | 35 | 4 | | 10 | |
| 35x5 | | | | | | | | | |
| 0977201 | 3308189772013 | | 14 | 300 | 35 | 5 | Vrac gencodé | 5 | |
| 1113201 | 3308181132013 | | 14 | 400 | 35 | 5 | Vrac gencodé | 5 | |
| 1113101 | 3308181131016 | | 14 | 500 | 35 | 5 | Vrac gencodé | 5 | |
| 0733601 | 3308180035797 | | 14 | 600 | 35 | 5 | Vrac gencodé | 5 | |
| 0733801 | 3308180035803 | | 14 | 700 | 35 | 5 | Vrac gencodé | 5 | |
| 0786901 | 3308180035827 | | 14 | 800 | 35 | 5 | Vrac gencodé | 5 | |
| 40x5 | | | | | | | | | |
| 0733901 | 3308187339010 | | 14 | 800 | 40 | 5 | Vrac gencodé | 5 | |
| 0265401 | 3308182654019 | | 14 | 1000 | 40 | 5 | Vrac gencodé | 5 | |
| 0707306 | 3308187073006 | DP | 14 | 300 | 40 | 5 | Vrac gencodé | 5 | |
| 0707406 | 3308187074003 | DP | 14 | 400 | 40 | 5 | Vrac gencodé | 5 | |
| 0707506 | 3308187075000 | DP | 14 | 500 | 40 | 5 | Vrac gencodé | 5 | |
| 0707606 | 3308187076007 | DP | 14 | 600 | 40 | 5 | Vrac gencodé | 5 | |
| 0787901 | 3308180035865 | | 16 | 800 | 40 | 5 | Vrac gencodé | 5 | |
| 0789101 | 3308180035940 | | 16 | 1000 | 40 | 5 | Vrac gencodé | 5 | |
| 0797701 | 3308180035988 | | 16 | 1200 | 40 | 5 | Vrac gencodé | 5 | |
| 0787903 | 3308180035872 | Z.BLANC | 16 | 800 | 40 | 5 | Vrac gencodé | 5 | |
| 0789103 | 3308180035957 | Z.BLANC | 16 | 1000 | 40 | 5 | Vrac gencodé | 5 | |
| 0797703 | 3308180035995 | Z.BLANC | 16 | 1200 | 40 | 5 | Vrac gencodé | 5 | |
| 40x6 | | | | | | | | | |
| 0977301 | 3308189773010 | | 14 | 300 | 40 | 6 | Vrac gencodé | 5 | |
| 0977401 | 3308189774017 | | 14 | 400 | 40 | 6 | Vrac gencodé | 5 | |
| 0977501 | 3308189775014 | | 14 | 500 | 40 | 6 | Vrac gencodé | 5 | |
| 0977601 | 3308189776011 | | 14 | 600 | 40 | 6 | Vrac gencodé | 5 | |
| 0977701 | 3308189777018 | | 14 | 700 | 40 | 6 | Vrac gencodé | 5 | |
| 0977801 | 3308189778015 | | 14 | 800 | 40 | 6 | Vrac gencodé | 5 | |
| 0977901 | 3308189779012 | | 14 | 1000 | 40 | 6 | Vrac gencodé | 5 | |

Pentures coudées bout droit

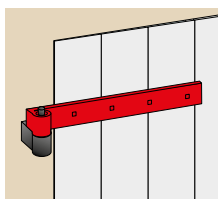

Penture coudée bout droit

| Code | Gencod | | D | L | I | Ep. | Type packaging | |
|-------------|---------------|--|----|-----|----|-----|----------------|---|
| 35x4 | | | | | | | | |
| 0793801 | 3308180036879 | | 14 | 400 | 35 | 4 | Vrac gencodé | 1 |
| 0794601 | 3308180036916 | | 14 | 500 | 35 | 4 | Vrac gencodé | 1 |
| 0794701 | 3308180038590 | | 14 | 600 | 35 | 4 | Vrac gencodé | 1 |

Pentures queue de carpe

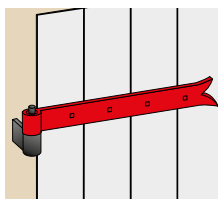
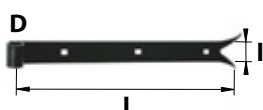

Penture bout queue de carpe

| Code | Gencod | | D | L | I | Ep. | Type packaging | |
|-------------|---------------|---------|----|------|----|-----|----------------|----|
| 30x4 | | | | | | | | |
| 0663801 | 3308180036053 | | 14 | 300 | 30 | 4 | Vrac gencodé | 5 |
| 0663901 | 3308180036060 | | 14 | 400 | 30 | 4 | Vrac gencodé | 5 |
| 0664801 | 3308180036077 | | 14 | 500 | 30 | 4 | Vrac gencodé | 5 |
| 0663803 | 3308186638039 | Z.BLANC | 14 | 300 | 30 | 4 | Vrac gencodé | 5 |
| 0663903 | 3308186639036 | Z.BLANC | 14 | 400 | 30 | 4 | Vrac gencodé | 5 |
| 0664803 | 3308180038781 | Z.BLANC | 14 | 500 | 30 | 4 | Vrac gencodé | 5 |
| 35x4 | | | | | | | | |
| 0665801 | 3308180036091 | | 14 | 300 | 35 | 4 | Vrac gencodé | 5 |
| 0665901 | 3308180036107 | | 14 | 400 | 35 | 4 | Vrac gencodé | 5 |
| 0667001 | 3308180036114 | | 14 | 500 | 35 | 4 | Vrac gencodé | 5 |
| 0667501 | 3308180036121 | | 14 | 600 | 35 | 4 | Vrac gencodé | 5 |
| 0667701 | 3308180036138 | | 14 | 700 | 35 | 4 | Vrac gencodé | 5 |
| 0667801 | 3308180036145 | | 14 | 800 | 35 | 4 | Vrac gencodé | 5 |
| 0665803 | 3308180038415 | Z.BLANC | 14 | 300 | 35 | 4 | Vrac gencodé | 5 |
| 0665903 | 3308180038422 | Z.BLANC | 14 | 400 | 35 | 4 | Vrac gencodé | 5 |
| 0667003 | 3308186670039 | Z.BLANC | 14 | 500 | 35 | 4 | Vrac gencodé | 5 |
| 0667703 | 3308186677038 | Z.BLANC | 14 | 700 | 35 | 4 | Vrac gencodé | 5 |
| 0943601 | 3308189436014 | | 14 | 300 | 35 | 4 | | 20 |
| 0943701 | 3308189437011 | | 14 | 400 | 35 | 4 | | 20 |
| 0943801 | 3308189438018 | | 14 | 500 | 35 | 4 | | 10 |
| 0943901 | 3308189439015 | | 14 | 600 | 35 | 4 | | 10 |
| 35x5 | | | | | | | | |
| 0808501 | 3308188085015 | | 14 | 300 | 35 | 5 | Vrac gencodé | 5 |
| 0808701 | 3308188087019 | | 14 | 400 | 35 | 5 | Vrac gencodé | 5 |
| 0808901 | 3308188089013 | | 14 | 500 | 35 | 5 | Vrac gencodé | 5 |
| 0809101 | 3308188091016 | | 14 | 600 | 35 | 5 | Vrac gencodé | 5 |
| 40x5 | | | | | | | | |
| 0735501 | 3308187355010 | | 14 | 800 | 40 | 5 | Vrac gencodé | 5 |
| 0265501 | 3308182655016 | | 14 | 1000 | 40 | 5 | Vrac gencodé | 5 |
| 0788301 | 3308180036220 | | 16 | 800 | 40 | 5 | Vrac gencodé | 5 |
| 0789301 | 3308180036305 | | 16 | 1000 | 40 | 5 | Vrac gencodé | 5 |
| 0797801 | 3308180036343 | | 16 | 1200 | 40 | 5 | Vrac gencodé | 5 |

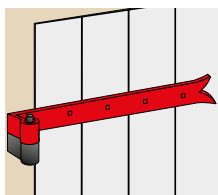

Penture col équerre bout queue de carpe

| Code | Gencod | | D | L | I | Ep. | Type packaging | |
|-------------|---------------|--|----|-----|----|-----|----------------|---|
| 35x4 | | | | | | | | |
| 0785601 | 3308187856012 | | 14 | 500 | 35 | 4 | Vrac gencodé | 1 |
| 0785701 | 3308187857019 | | 14 | 600 | 35 | 4 | Vrac gencodé | 1 |

Equerres bout droit

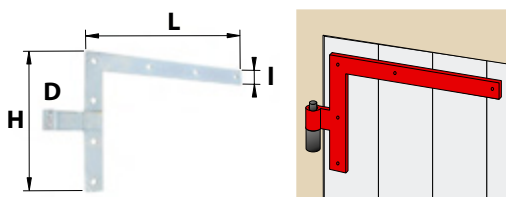
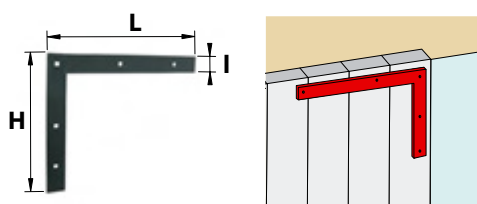
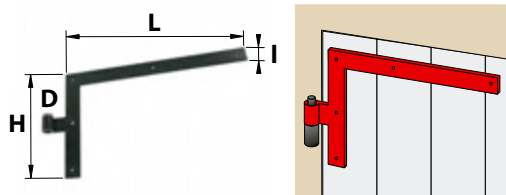

Equerre bout droit

| Code | Gencod | | D | L | H | I | Ep. | Déport | Type packaging | |
|---------------------------------------|---------------|--|----|-----|-----|----|-----|--------|----------------|---|
| Modèle haut gauche / bas droit | | | | | | | | | | |
| 0819701 | 3308180037616 | | 14 | 300 | 250 | 35 | 4 | 50 | Vrac gencodé | 1 |
| Modèle haut droit / bas gauche | | | | | | | | | | |
| 0819601 | 3308180037579 | | 14 | 300 | 250 | 35 | 4 | 50 | Vrac gencodé | 1 |
| La paire | | | | | | | | | | |
| 0389701 | 3308183897019 | | 14 | 300 | 250 | 35 | 4 | 50 | Vrac gencodé | 1 |
| 0944001 | 3308189440011 | | 14 | 300 | 250 | 35 | 4 | 50 | | 4 |
| Modèle haut gauche / bas droit | | | | | | | | | | |
| 176010 | 3221681760107 | | 16 | 800 | 400 | 40 | 6 | 37 | Vrac gencodé | 1 |
| Modèle haut droit / bas gauche | | | | | | | | | | |
| 176011 | 3221681760114 | | 16 | 800 | 400 | 40 | 6 | 37 | Vrac gencodé | 1 |

Contre-équerre bout droit

| Code | Gencod | | L | H | I | Ep. | Type packaging | |
|---------|---------------|--|-----|-----|----|-----|----------------|---|
| 0459401 | 3308184594016 | | 300 | 250 | 35 | 4 | Vrac gencodé | 1 |

Equerre bout droit

| Code | Gencod | | D | L | H | I | Ep. | Déport | Type packaging | |
|---------------------------------------|---------------|---------|----|-----|-----|----|-----|--------|----------------|---|
| Modèle haut gauche / bas droit | | | | | | | | | | |
| 752805 | 3026727528051 | Z.BLANC | 14 | 300 | 220 | 30 | 4 | 55 | Vrac gencodé | 4 |
| Modèle haut droit / bas gauche | | | | | | | | | | |
| 752804 | 3026727528044 | Z.BLANC | 14 | 300 | 220 | 30 | 4 | 55 | Vrac gencodé | 4 |

Equerres queue de carpe

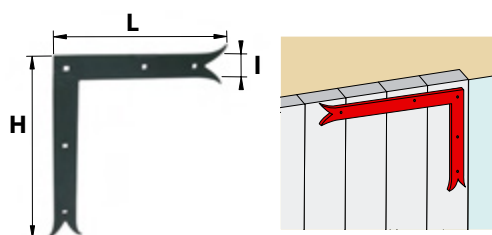
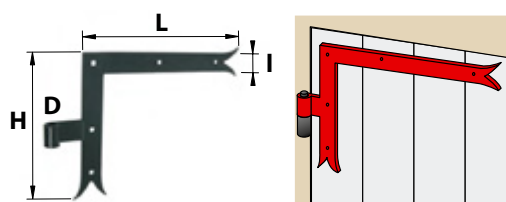

Equerre bout queue de carpe

| Code | Gencod | | D | L | H | I | Ep. | Déport | Type packaging | |
|---------------------------------------|---------------|--|----|-----|-----|----|-----|--------|----------------|---|
| Modèle haut gauche / bas droit | | | | | | | | | | |
| 0793201 | 3308180037739 | | 14 | 300 | 250 | 35 | 4 | 50 | Vrac gencodé | 1 |
| Modèle haut droit / bas gauche | | | | | | | | | | |
| 0793401 | 3308180037692 | | 14 | 300 | 250 | 35 | 4 | 50 | Vrac gencodé | 1 |
| La paire | | | | | | | | | | |
| 0382801 | 3308183828013 | | 14 | 300 | 250 | 35 | 4 | 50 | Vrac gencodé | 1 |

Contre-équerre bout queue de carpe

| Code | Gencod | | L | H | I | Ep. | Type packaging | |
|---------|---------------|--|-----|-----|----|-----|----------------|---|
| 0792801 | 3308180037814 | | 300 | 250 | 35 | 4 | Vrac gencodé | 1 |

Tés bout droit

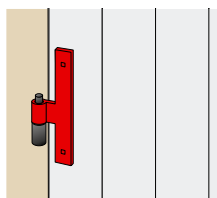
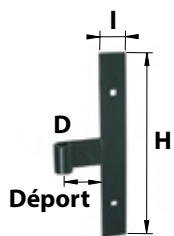

Té bout droit

| Code | Gencod | | D | H | I | Ep. | Déport | Type packaging | |
|---------|---------------|---------|----|-----|----|-----|--------|----------------|----|
| 0819801 | 3308180037654 | | 14 | 250 | 35 | 4 | 50 | Vrac gencodé | 1 |
| 0819803 | 3308180037661 | Z.BLANC | 14 | 250 | 35 | 4 | 50 | Vrac gencodé | 1 |
| 0942601 | 3308189426015 | | 14 | 250 | 35 | 4 | 50 | | 15 |

Tés queue de carpe

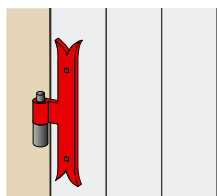
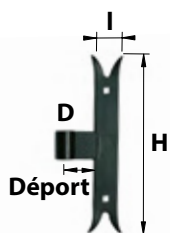

Té bout queue de carpe

| Code | Gencod | | D | H | I | Ep. | Déport | Type packaging | |
|---------|---------------|--|----|-----|----|-----|--------|----------------|---|
| 0793001 | 3308180037777 | | 14 | 250 | 35 | 4 | 50 | Vrac gencodé | 1 |

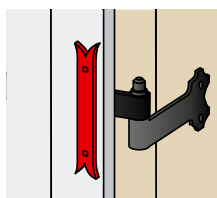

Contre-té bout queue de carpe

| Code | Gencod | | H | I | Ep. | Type packaging | |
|---------|---------------|--|-----|----|-----|----------------|---|
| 0793601 | 3308180037852 | | 250 | 35 | 4 | Vrac gencodé | 1 |

Kit penture

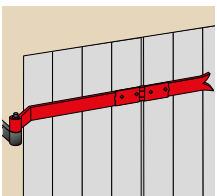
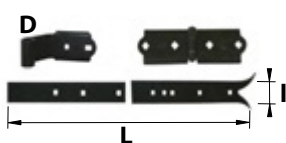

Kit penture spécial volet double

| Code | Gencod | | D | L | I | Ep. | Type packaging | |
|---------|---------------|--|----|------|----|-----|----------------|---|
| 0109405 | 3308181094052 | | 14 | 1123 | 35 | 4 | Vrac gencodé | 1 |

Composition
Nœud déporté D14 - Charnière - Éléments de penture recoupables.

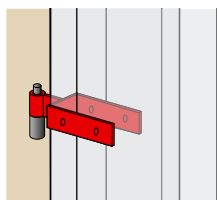
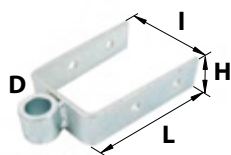

Penture nord U

| Code | Gencod | | D | L | H | I | Ep. | Type packaging | |
|---------|---------------|---------|----|-----|----|----|-----|----------------|---|
| M685900 | 3026726859002 | Z.BLANC | 14 | 135 | 35 | 80 | 5 | Vrac gencodé | 5 |

Pentures festonnées

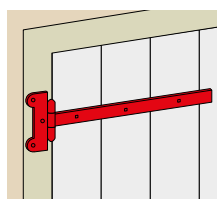

Penture festonnée

| Code | Gencod | | L | I | Ep. | Type packaging | |
|---------|---------------|---------|-----|----|-----|----------------|---|
| 629460 | 3479046294600 | | 300 | 30 | 4 | Vrac gencodé | 5 |
| 629465 | 3479046294655 | | 400 | 30 | 4 | Vrac gencodé | 5 |
| 629470 | 3479046294709 | | 500 | 30 | 4 | Vrac gencodé | 5 |
| 629475 | 3479046294754 | | 600 | 30 | 4 | Vrac gencodé | 5 |
| 9629600 | 3479046296000 | Z.BLANC | 300 | 30 | 4 | Vrac gencodé | 5 |
| 629605 | 3479046296055 | Z.BLANC | 400 | 30 | 4 | Vrac gencodé | 5 |
| 629610 | 3479046296109 | Z.BLANC | 500 | 30 | 4 | Vrac gencodé | 5 |
| 629615 | 3479046296154 | Z.BLANC | 600 | 30 | 4 | Vrac gencodé | 5 |

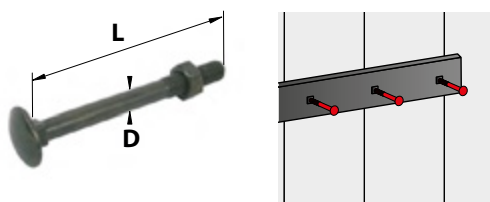

Boulon TRCC

| Code | Gencod | | D | L | Type packaging | |
|------------|---------------|---------|---|----|-------------------|---|
| x8 | | | | | | |
| 629765 | 3221686297653 | | 6 | 45 | Brochable gencodé | 1 |
| 629767 | 3221686297677 | | 6 | 70 | Brochable gencodé | 1 |
| 0955504 | 3308189555043 | | 7 | 45 | Brochable gencodé | 1 |
| 629798 | 3221686297981 | | 7 | 60 | Brochable gencodé | 1 |
| 0955604 | 3308189556040 | | 7 | 70 | Brochable gencodé | 1 |
| 629793 | 3221686297936 | Z.BLANC | 7 | 45 | Brochable gencodé | 1 |
| 629797 | 3221686297974 | Z.BLANC | 7 | 70 | Brochable gencodé | 1 |
| x30 | | | | | | |
| 629761 | 3221686297615 | | 6 | 45 | Brochable gencodé | 1 |
| 629763 | 3221686297639 | | 6 | 70 | Brochable gencodé | 1 |
| 629791 | 3221686297912 | | 7 | 45 | Brochable gencodé | 1 |
| 629799 | 3221686297998 | | 7 | 60 | Brochable gencodé | 1 |
| 629795 | 3221686297950 | | 7 | 70 | Brochable gencodé | 1 |

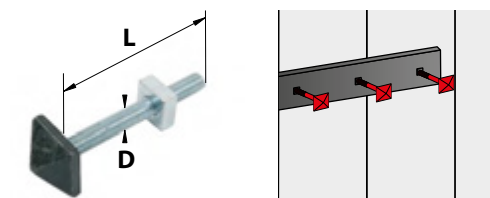

Boulon tête diamant (x4)

| Code | Gencod | | D | L | Type packaging | |
|---------|---------------|--|---|----|-------------------|---|
| 0953401 | 3308189534017 | | 7 | 60 | Brochable gencodé | 1 |

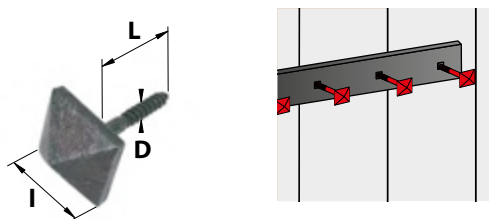

Clou vis tête diamant (x4)

| Code | Gencod | | D | L | I | Type packaging | |
|---------|---------------|--|---|----|----|-------------------|---|
| 0996600 | 3308189966009 | | 5 | 37 | 15 | Brochable gencodé | 1 |
| 0996700 | 3308189967006 | | 5 | 37 | 25 | Brochable gencodé | 1 |

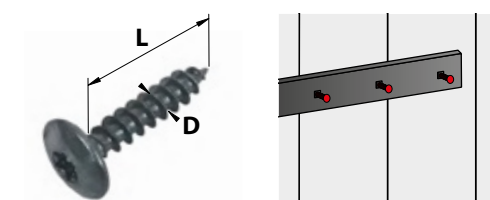

Vis peinture

| Code | Gencod | | D | L | Type packaging | |
|------------|---------------|---------|---|----|-------------------|---|
| x8 | | | | | | |
| 0254201 | 3308182542019 | | 7 | 30 | Brochable gencodé | 1 |
| 0254601 | 3308182546017 | | 7 | 50 | Brochable gencodé | 1 |
| x30 | | | | | | |
| 0996900 | 3308189969000 | Z.BLANC | 6 | 30 | Brochable gencodé | 1 |
| 0997000 | 3308189970006 | | 6 | 30 | Brochable gencodé | 1 |
| 629780 | 3221686297806 | | 7 | 30 | Brochable gencodé | 1 |
| 0996800 | 3308189968003 | | 7 | 50 | Brochable gencodé | 1 |

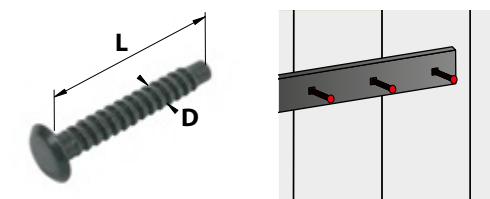

Vis peinture sécurité (x20)

| Code | Gencod | | D | L | Type packaging | |
|---------|---------------|--|---|----|-------------------|---|
| 0953204 | 3308189532044 | | 7 | 45 | Brochable gencodé | 1 |

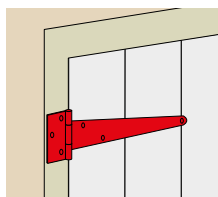
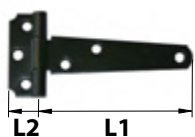

Penture anglaise légère

| Code | Gencod | | L1 | L2 | Ep. | Type packaging | |
|---------|---------------|---------|-----|------|-----|----------------|----|
| 0503401 | 3308185034016 | | 75 | 20,5 | 1,5 | Vrac gencodé | 10 |
| 0503501 | 3308185035013 | | 100 | 20,5 | 1,5 | Vrac gencodé | 10 |
| 0095704 | 3308180957044 | | 125 | 20,5 | 1,5 | Vrac gencodé | 10 |
| 0503402 | 3308185034023 | Z.BLANC | 75 | 20,5 | 1,5 | Vrac gencodé | 10 |
| 0503502 | 3308185035020 | Z.BLANC | 100 | 20,5 | 1,5 | Vrac gencodé | 10 |
| 0095702 | 3308180957020 | Z.BLANC | 125 | 20,5 | 1,5 | Vrac gencodé | 10 |
| 0503602 | 3308185036027 | Z.BLANC | 150 | 43,7 | 1,5 | Vrac gencodé | 10 |
| 0240802 | 3308182408025 | Z.BLANC | 75 | 20,5 | 1,5 | | 50 |
| 0240902 | 3308182409022 | Z.BLANC | 100 | 20,5 | 1,5 | | 30 |
| 0241002 | 3308182410028 | Z.BLANC | 125 | 20,5 | 1,5 | | 50 |
| 0330302 | 3308183303022 | Z.BLANC | 150 | 43,7 | 1,5 | | 20 |

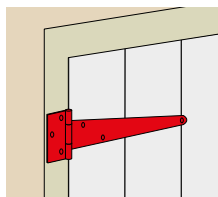
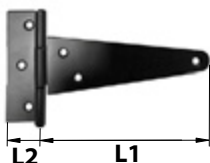

Penture anglaise

| Code | Gencod | | L1 | L2 | Ep. | Type packaging | |
|---------|---------------|---------|-----|------|-----|----------------|----|
| 9624100 | 3479046241000 | | 80 | 25 | 1,5 | Vrac gencodé | 10 |
| 624105 | 3479046241055 | | 100 | 25 | 1,5 | Vrac gencodé | 10 |
| 624110 | 3479046241109 | | 120 | 25 | 1,5 | Vrac gencodé | 10 |
| 624115 | 3479046241154 | | 150 | 25 | 1,5 | Vrac gencodé | 10 |
| 624090 | 3479046240904 | Z.BLANC | 80 | 25 | 1,5 | Vrac gencodé | 10 |
| 1902102 | 3479046240911 | Z.BLANC | 100 | 25 | 1,5 | Vrac gencodé | 10 |
| 624092 | 3479046240928 | Z.BLANC | 120 | 25 | 1,5 | Vrac gencodé | 10 |
| 0330302 | 3308183303022 | Z.BLANC | 150 | 43,7 | 1,5 | | 20 |

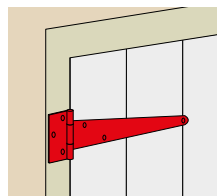

Penture anglaise

| Code | Gencod | | L1 | L2 | Ep. | Type packaging | |
|---------|---------------|---------|-----|------|-----|----------------|----|
| 624155 | 3479046241550 | | 200 | 42,7 | 2 | Vrac gencodé | 10 |
| 624160 | 3479046241604 | | 250 | 42,7 | 2 | Vrac gencodé | 10 |
| 624165 | 3479046241659 | | 300 | 42,7 | 2 | Vrac gencodé | 10 |
| 624170 | 3479046241703 | | 350 | 42,7 | 2 | Vrac gencodé | 10 |
| 624094 | 3479046240942 | Z.BLANC | 200 | 42,7 | 2 | Vrac gencodé | 10 |
| 624095 | 3479046240959 | Z.BLANC | 250 | 42,7 | 2 | Vrac gencodé | 10 |
| 624096 | 3479046240966 | Z.BLANC | 300 | 42,7 | 2 | Vrac gencodé | 10 |
| 624070 | 3479046240706 | Z.BLANC | 350 | 42,7 | 2 | Vrac gencodé | 10 |
| 0241102 | 3308182411025 | Z.BLANC | 200 | 42,7 | 2 | | 20 |
| 0241202 | 3308182412022 | Z.BLANC | 300 | 42,7 | 2 | | 30 |

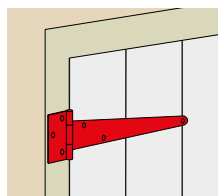

Penture anglaise forte

| Code | Gencod | | L1 | L2 | Ep. | Type packaging | |
|---------|---------------|---------|-----|------|-----|----------------|----|
| 8207015 | 3221688207018 | | 150 | 41,7 | 2,5 | Vrac gencodé | 10 |
| 8207020 | 3221688207216 | | 200 | 41,7 | 2,5 | Vrac gencodé | 10 |
| 8207025 | 3221688207261 | | 250 | 41,7 | 2,5 | Vrac gencodé | 10 |
| 8207030 | 3221688207315 | | 300 | 41,7 | 2,5 | Vrac gencodé | 10 |
| 8207035 | 3221688207353 | | 350 | 41,7 | 2,5 | Vrac gencodé | 10 |
| 8207040 | 3221688207407 | | 400 | 41,7 | 2,5 | Vrac gencodé | 10 |
| 8207050 | 3221688207506 | | 500 | 41,7 | 2,5 | Vrac gencodé | 10 |
| 8207060 | 3221688207605 | | 600 | 41,7 | 2,5 | Vrac gencodé | 10 |
| 7207150 | 3221687207156 | Z.BLANC | 150 | 41,7 | 2,5 | Vrac gencodé | 10 |
| 7207200 | 3221687207200 | Z.BLANC | 200 | 41,7 | 2,5 | Vrac gencodé | 10 |
| 7207250 | 3221687207255 | Z.BLANC | 250 | 41,7 | 2,5 | Vrac gencodé | 10 |
| 7207300 | 3221687207309 | Z.BLANC | 300 | 41,7 | 2,5 | Vrac gencodé | 10 |
| 7207350 | 3221687207354 | Z.BLANC | 350 | 41,7 | 2,5 | Vrac gencodé | 10 |
| 7207400 | 3221687207408 | Z.BLANC | 400 | 41,7 | 2,5 | Vrac gencodé | 10 |
| 7207500 | 3221687207507 | Z.BLANC | 500 | 41,7 | 2,5 | Vrac gencodé | 10 |
| 7207600 | 3221687207606 | Z.BLANC | 600 | 41,7 | 2,5 | Vrac gencodé | 10 |
| 0465202 | 3308184652020 | Z.BLANC | 400 | 41,7 | 2,5 | | 15 |
| 0465502 | 3308184655021 | Z.BLANC | 500 | 41,7 | 2,5 | | 15 |
| 0465602 | 3308184656028 | Z.BLANC | 600 | 41,7 | 2,5 | | 15 |

Penture anglaise avec axe composite

| Code | Gencod | | L1 | L2 | Ep. | Type packaging | |
|--------|---------------|---------|-------|----|-----|----------------|---|
| 756915 | 3026727569153 | | 144 | 45 | 2 | Vrac gencodé | 5 |
| 756920 | 3026727569207 | | 194 | 45 | 2 | Vrac gencodé | 5 |
| 756925 | 3026727569252 | | 244 | 45 | 2 | Vrac gencodé | 5 |
| 757930 | 3026727579305 | | 292,8 | 45 | 2 | Vrac gencodé | 5 |
| 757935 | 3026727579350 | | 342,8 | 45 | 2 | Vrac gencodé | 5 |
| 757940 | 3026727579404 | | 392,8 | 45 | 2 | Vrac gencodé | 5 |
| 757950 | 3026727579503 | | 492,8 | 45 | 2 | Vrac gencodé | 5 |
| 757960 | 3026727579602 | | 572,8 | 45 | 2 | Vrac gencodé | 5 |
| 756815 | 3026727568156 | Z.BLANC | 144 | 45 | 2 | Vrac gencodé | 5 |
| 756820 | 3026727568200 | Z.BLANC | 194 | 45 | 2 | Vrac gencodé | 5 |
| 756825 | 3026727568255 | Z.BLANC | 244 | 45 | 2 | Vrac gencodé | 5 |
| 757830 | 3026727578308 | Z.BLANC | 292,8 | 45 | 2 | Vrac gencodé | 5 |
| 757835 | 3026727578353 | Z.BLANC | 342,8 | 45 | 2 | Vrac gencodé | 5 |
| 757840 | 3026727578407 | Z.BLANC | 392,8 | 45 | 2 | Vrac gencodé | 5 |
| 757850 | 3026727578506 | Z.BLANC | 492,8 | 45 | 2 | Vrac gencodé | 5 |
| 757860 | 3026727578605 | Z.BLANC | 572,8 | 45 | 2 | Vrac gencodé | 5 |

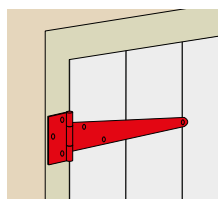
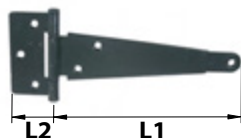

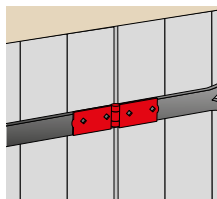
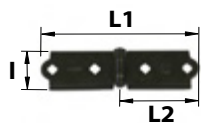

Charnière à penture

| Code | Gencod | | L1 | L2 | I | Type packaging | |
|--------|---------------|--|-----|----|----|----------------|---|
| 110040 | 3221681100408 | | 170 | 85 | 35 | Vrac gencodé | 1 |
| 110036 | 3221681100361 | | 170 | 85 | 40 | Vrac gencodé | 1 |



Couplet niçois (x2) + visserie

| Code | Gencod | | H | I | Ep. | Type packaging | |
|---------|---------------|--|-----|----|-----|-------------------|---|
| 0952501 | 3308189525015 | | 158 | 47 | 2 | Brochable gencodé | 1 |

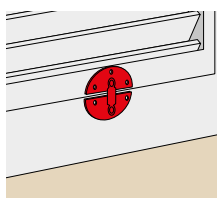
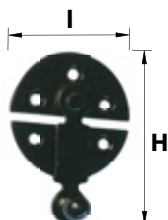

Violet niçois (x2) + visserie

| Code | Gencod | | H | I | Ep. | Type packaging | |
|---------|---------------|--|----|----|-----|-------------------|---|
| 0953101 | 3308189531016 | | 95 | 65 | 2,5 | Brochable gencodé | 1 |

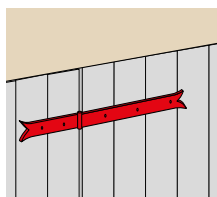

Charnière de jumelage bout queue de carpe

| Code | Gencod | | L1 | L2 | I | Ep. | Type packaging | |
|---------|---------------|--|-----|-----|----|-----|----------------|---|
| 0742801 | 3308187428011 | | 400 | 150 | 35 | 4 | Vrac gencodé | 1 |
| 0744601 | 3308187446015 | | 500 | 150 | 35 | 6 | Vrac gencodé | 1 |

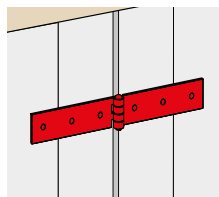
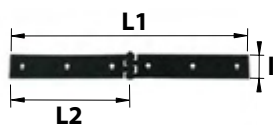

Charnière forte

| Code | Gencod | | L1 | L2 | I | Ep. | Type packaging | |
|---------|---------------|--|-----|-----|----|-----|----------------|----|
| 0238801 | 3308182388013 | | 200 | 100 | 40 | 4 | Vrac gencodé | 10 |
| 0238901 | 3308182389010 | | 300 | 150 | 40 | 4 | Vrac gencodé | 10 |
| 0240001 | 3308182400012 | | 400 | 200 | 40 | 4 | Vrac gencodé | 10 |

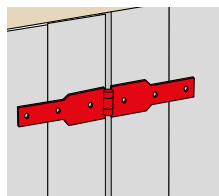
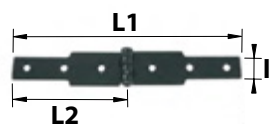

Charnière à congés

| Code | Gencod | | L1 | L2 | I | Ep. | Type packaging | |
|---------|---------------|---------|-----|-----|----|-----|----------------|----|
| 542350 | 3221685423503 | | 200 | 100 | 30 | 2,5 | Vrac gencodé | 10 |
| 542360 | 3221685423602 | | 240 | 120 | 40 | 2,5 | Vrac gencodé | 10 |
| 542370 | 3221685423701 | | 280 | 140 | 50 | 2,5 | Vrac gencodé | 10 |
| 542320 | 3479045423209 | Z.BLANC | 200 | 100 | 30 | 2,5 | Vrac gencodé | 10 |
| 542330 | 3479045423308 | Z.BLANC | 240 | 120 | 40 | 2,5 | Vrac gencodé | 10 |
| 542340 | 3479045423407 | Z.BLANC | 280 | 140 | 50 | 2,5 | Vrac gencodé | 10 |
| 0280403 | 3308182804032 | Z.BLANC | 200 | 100 | 30 | 2,5 | | 50 |
| 0280503 | 3308182805039 | Z.BLANC | 240 | 120 | 40 | 2,5 | | 30 |
| 0280903 | 3308182809037 | Z.BLANC | 280 | 140 | 50 | 2,5 | | 20 |

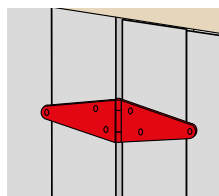

Charnière double axe composite

| Code | Gencod | | L | I | Ep. | Type packaging | |
|--------|---------------|---------|-----|----|-----|----------------|----|
| 757970 | 3026727579701 | | 300 | 50 | 2 | Vrac gencodé | 10 |
| 757971 | 3026727579718 | | 400 | 50 | 2 | Vrac gencodé | 10 |
| 757870 | 3026727578704 | Z.BLANC | 300 | 50 | 2 | Vrac gencodé | 10 |
| 757871 | 3026727578711 | Z.BLANC | 400 | 50 | 2 | Vrac gencodé | 10 |

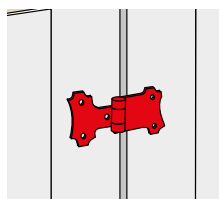
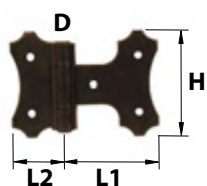

Charnière intermédiaire

| Code | Gencod | | D | L1 | L2 | H | Ep. | Type packaging | |
|---------|---------------|--|----|----|----|----|-----|----------------|----|
| 0637801 | 3308186378010 | | 14 | 83 | 47 | 95 | 4 | Vrac gencodé | 10 |

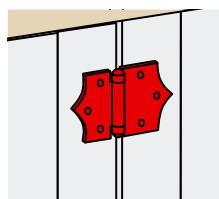
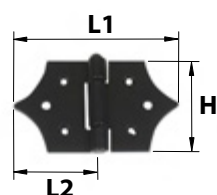

Charnière décorative

| Code | Gencod | | L1 | L2 | H | Ep. | Type packaging | |
|---------|---------------|---------|-----|----|----|-----|----------------|----|
| 0504701 | 3308185047016 | | 126 | 63 | 74 | 4 | Vrac gencodé | 10 |
| 0504703 | 3308185047030 | Z.BLANC | 126 | 63 | 74 | 4 | Vrac gencodé | 10 |
| 0241401 | 3308182414019 | | 126 | 63 | 74 | 4 | | 20 |
| 0241603 | 3308182416037 | Z.BLANC | 126 | 63 | 74 | 4 | | 20 |
| 0241803 | 3308182418031 | Z.BLANC | 170 | 85 | 74 | 4 | | 20 |

Gonds à sceller

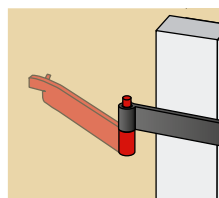
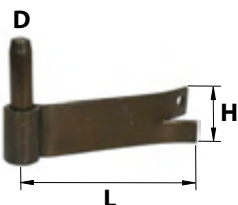

Gond à sceller simple

| Code | Gencod | | D | L | H | Ep. | Type packaging | |
|---------|---------------|---------|----|-----|----|-----|----------------|----|
| 0774801 | 3308180038040 | | 14 | 120 | 35 | 4 | Vrac gencodé | 10 |
| 0774803 | 3308180029901 | Z.BLANC | 14 | 120 | 35 | 4 | Vrac gencodé | 10 |

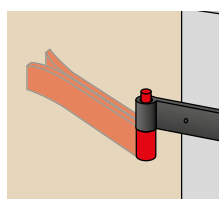
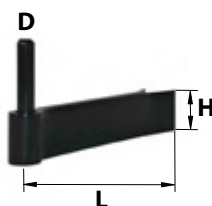

Gond à sceller renforcé

| Code | Gencod | | D | L | H | Ep. | Type packaging | |
|---------|---------------|---------|----|-----|----|-----|----------------|----|
| 0807701 | 3308180037883 | | 14 | 130 | 35 | 4 | Vrac gencodé | 10 |
| 579014 | 3479045790141 | | 14 | 150 | 35 | 4 | Vrac gencodé | 10 |
| 0807703 | 3308180037890 | Z.BLANC | 14 | 130 | 35 | 4 | Vrac gencodé | 10 |
| 579013 | 3479045790134 | Z.BLANC | 14 | 150 | 35 | 4 | Vrac gencodé | 10 |
| 0956701 | 3308189567015 | | 14 | 173 | 40 | 5 | Vrac gencodé | 10 |
| 735816 | 3026727358160 | Z.BLANC | 16 | 110 | 35 | 4 | Vrac gencodé | 5 |
| 0804801 | 3308180037913 | | 16 | 130 | 40 | 5 | Vrac gencodé | 10 |
| 0525601 | 3308180038866 | | 16 | 173 | 40 | 5 | Vrac gencodé | 10 |
| 0241301 | 3308182413012 | | 14 | 130 | 35 | 4 | | 30 |
| 0942501 | 3308189425018 | | 16 | 130 | 40 | 5 | | 30 |
| 0418301 | 3308184183012 | | 16 | 173 | 40 | 5 | | 10 |

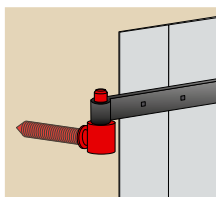
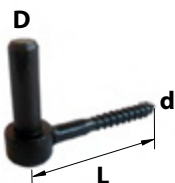

Gond à visser tirefond

| Code | Gencod | | D | L | d | Type packaging | |
|---------|---------------|---------|----|----|----|----------------|----|
| 0387201 | 3308183872016 | | 14 | 90 | 10 | Vrac gencodé | 10 |
| 0875201 | 3308188752016 | | 16 | 90 | 10 | Vrac gencodé | 10 |
| 0387203 | 3308183872030 | Z.BLANC | 14 | 90 | 10 | Vrac gencodé | 10 |
| 0875203 | 3308188752030 | Z.BLANC | 16 | 90 | 10 | Vrac gencodé | 10 |
| 0237901 | 3308182379011 | | 14 | 90 | 10 | | 50 |
| 0418601 | 3308184186013 | | 16 | 90 | 10 | | 50 |
| 0427001 | 3308184270019 | | 16 | 90 | 10 | | 30 |

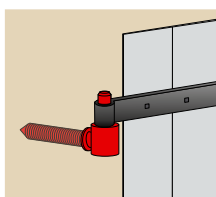
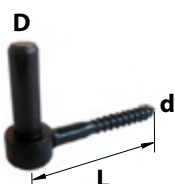

Gond à visser tirefond haut

| Code | Gencod | | D | L | d | Type packaging | |
|---------|---------------|----|----|----|----|----------------|----|
| 0350306 | 3308183503064 | DP | 14 | 90 | 10 | Vrac gencodé | 10 |

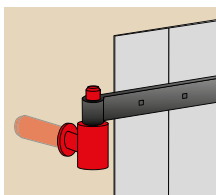

Gond à visser + cheville métal

| Code | Gencod | | D | L | d | Type packaging | |
|---------|---------------|---------|----|----|-----|----------------|----|
| 579152 | 3479045791520 | | 14 | 60 | M10 | Vrac gencodé | 5 |
| 579161 | 3479045791612 | | 16 | 85 | M10 | Vrac gencodé | 5 |
| 579151 | 3479045791513 | Z.BLANC | 14 | 60 | M10 | Vrac gencodé | 5 |
| 579160 | 3479045791605 | Z.BLANC | 16 | 85 | M10 | Vrac gencodé | 5 |
| 0237701 | 3308182377017 | | 14 | 60 | M10 | | 30 |

Utiliser le gabarit de perçage (Réf. 0109503 P.163) pour faciliter la pose de votre gond.

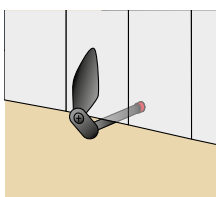

Cheville 4 segments (x2)

| Code | Gencod | | D | L | d | Type packaging | |
|---------|---------------|---------|----|----|-----|-------------------|---|
| 0423000 | 3308184230006 | Z.BLANC | 10 | 60 | M10 | Brochable gencodé | 1 |

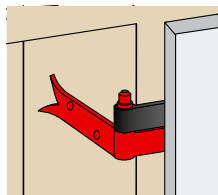
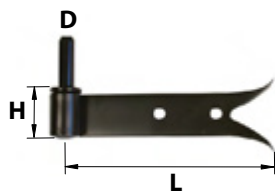

Gond à plaquer bout queue de carpe axe amovible

| Code | Gencod | | D | L | H | Ep. | Type packaging | |
|---------|---------------|---------|----|-----|----|-----|----------------|---|
| 0096401 | 3308180041293 | | 14 | 160 | 35 | 4 | Vrac gencodé | 1 |
| 739815 | 3026727398159 | Z.BLANC | 14 | 128 | 30 | 4 | Vrac gencodé | 5 |

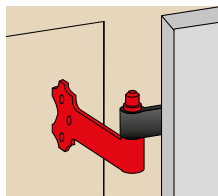
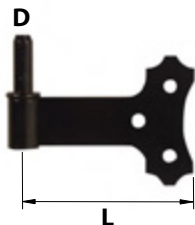

Gond à plaquer axe amovible

| Code | Gencod | | D | L | Ep. | Type packaging | |
|---------|---------------|--|----|-----|-----|----------------|---|
| 0524601 | 3308185246013 | | 14 | 125 | 4 | Vrac gencodé | 1 |

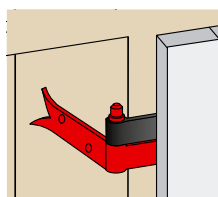
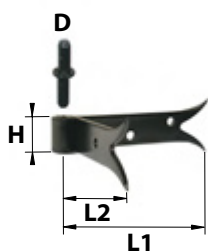

Gond d'angle bout queue de carpe axe amovible

| Code | Gencod | | D | L1 | L2 | I | Ep. | Type packaging | |
|---------|---------------|--|----|-----|-----|----|-----|----------------|---|
| 0805401 | 3308180038637 | | 14 | 160 | 130 | 35 | 5 | Vrac gencodé | 1 |

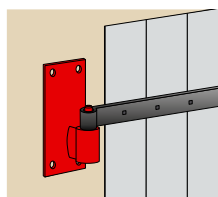
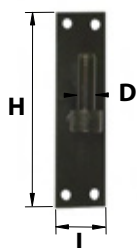

Gond sur platine bout droit

| Code | Gencod | | D | H | I | Ep. | Type packaging | |
|---------|---------------|---------|----|-----|----|-----|----------------|----|
| 0526101 | 3308185261016 | | 14 | 120 | 40 | 3 | Vrac gencodé | 5 |
| 179302 | 3221681793020 | | 14 | 180 | 40 | 3 | Vrac gencodé | 5 |
| 0526106 | 3308185261061 | DP | 14 | 120 | 40 | 3 | Vrac gencodé | 5 |
| 0526103 | 3308185261030 | Z.BLANC | 14 | 120 | 40 | 3 | Vrac gencodé | 5 |
| 179301 | 3221681793013 | Z.BLANC | 14 | 180 | 40 | 3 | Vrac gencodé | 5 |
| 179320 | 3221681793204 | Z.BLANC | 16 | 180 | 40 | 3 | Vrac gencodé | 5 |
| 0942401 | 3308189424011 | | 16 | 120 | 40 | 3 | | 20 |

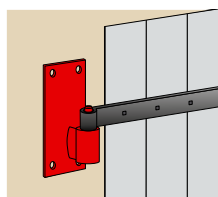
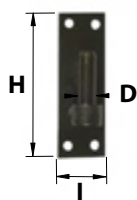

Gond sur platine courte bout droit

| Code | Gencod | | D | H | I | Ep. | Type packaging | |
|---------|---------------|---------|----|-----|----|-----|----------------|----|
| 0526201 | 3308185262013 | | 16 | 120 | 40 | 3 | Vrac gencodé | 5 |
| 0526203 | 3308185262037 | Z.BLANC | 16 | 120 | 40 | 3 | Vrac gencodé | 5 |
| 0257301 | 3308182573013 | | 14 | 120 | 40 | 3 | | 20 |

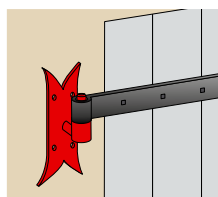
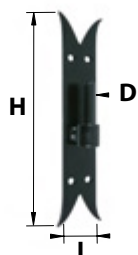

Gond sur platine bout queue de carpe

| Code | Gencod | | D | H | I | Ep. | Type packaging | |
|---------|---------------|---------|----|-----|----|-----|----------------|----|
| 0994301 | 3308189943017 | | 14 | 220 | 40 | 3 | Vrac gencodé | 5 |
| 0994401 | 3308189944014 | | 16 | 220 | 40 | 3 | Vrac gencodé | 5 |
| 0994306 | 3308189943062 | DP | 14 | 220 | 40 | 3 | Vrac gencodé | 5 |
| 0994302 | 3308189943024 | Z.BLANC | 14 | 220 | 40 | 3 | Vrac gencodé | 5 |
| 0242201 | 3308182422014 | | 14 | 220 | 40 | 3 | | 10 |

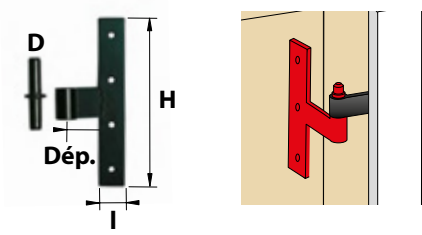

Gond sur té bout droit - Axe amovible

| Code | Gencod | | D | H | I | Ep. | Déport | Type packaging | |
|--------|---------------|--|----|-----|----|-----|--------|----------------|---|
| 579405 | 3479045794057 | | 14 | 190 | 30 | 5 | 35 | Vrac gencodé | 5 |

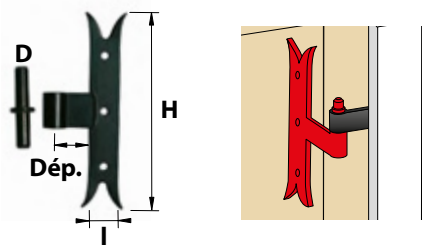

Gond sur té bout queue de carpe - Axe amovible

| Code | Gencod | | D | H | I | Ep. | Déport | Type packaging | |
|---------|---------------|--|----|-----|----|-----|--------|----------------|---|
| 579401 | 3479045794019 | | 14 | 190 | 30 | 5 | 35 | Vrac gencodé | 5 |
| 0964501 | 3308189645010 | | 14 | 235 | 35 | 4 | 70 | Vrac gencodé | 5 |

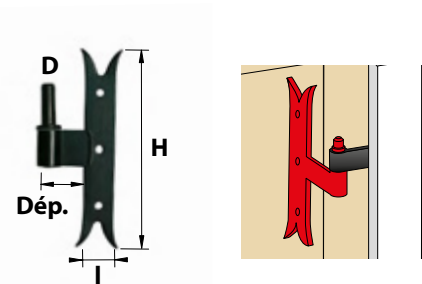

Gond sur té bout queue de carpe

| Code | Gencod | | D | H | I | Ep. | Déport | Type packaging | |
|----------------------|---------------|--|----|-----|----|-----|--------|----------------|----|
| Modèle Droite | | | | | | | | | |
| 0288101 | 3308182881019 | | 14 | 235 | 35 | 4 | 70 | | 10 |
| Modèle Gauche | | | | | | | | | |
| 0288201 | 3308182882016 | | 14 | 235 | 35 | 4 | 70 | | 10 |

Modèle gauche

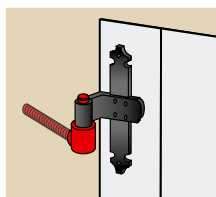
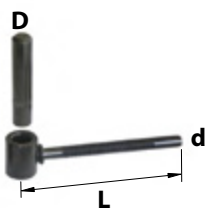

Gond à scellement chimique

| Code | Gencod | | D | L | d | Type packaging | |
|---------|---------------|---------|----|-----|-----|----------------|----|
| 0904104 | 3308189041041 | | 14 | 85 | M10 | Vrac gencodé | 5 |
| 0904204 | 3308189042048 | | 16 | 85 | M10 | Vrac gencodé | 5 |
| 0904304 | 3308189043045 | | 14 | 130 | M10 | Vrac gencodé | 5 |
| 0904404 | 3308189044042 | | 16 | 130 | M10 | Vrac gencodé | 5 |
| 0904103 | 3308189041034 | Z.BLANC | 14 | 85 | M10 | Vrac gencodé | 5 |
| 0904303 | 3308189043038 | Z.BLANC | 14 | 130 | M10 | Vrac gencodé | 5 |
| 0904403 | 3308189044035 | Z.BLANC | 16 | 130 | M10 | Vrac gencodé | 5 |
| 0260801 | 3308182608012 | | 14 | 85 | M10 | | 30 |
| 0241901 | 3308182419014 | | 14 | 130 | M10 | | 30 |
| 0418404 | 3308184184040 | | 16 | 130 | M10 | | 30 |

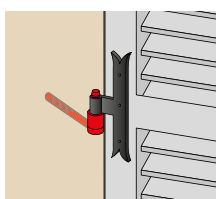
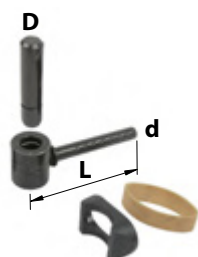

Polygond à clips renforcé fer à béton

| Code | Gencod | | D | L | d | Type packaging | |
|---------|---------------|--|----|-----|-----|----------------|---|
| 0980001 | 3308189800013 | | 14 | 70 | M10 | Vrac gencodé | 5 |
| 0980101 | 3308189801010 | | 14 | 115 | M10 | Vrac gencodé | 5 |

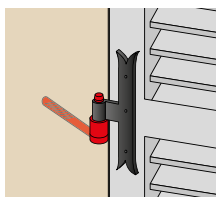

Polygond à clips

| Code | Gencod | | D | L | d | Type packaging | |
|---------|---------------|--|----|-----|-----|----------------|---|
| 0273901 | 3308182739013 | | 14 | 70 | M10 | Vrac gencodé | 5 |
| 0274001 | 3308182740019 | | 16 | 70 | M10 | Vrac gencodé | 5 |
| 0980301 | 3308189803014 | | 14 | 130 | M10 | Vrac gencodé | 5 |
| 0980401 | 3308189804011 | | 16 | 130 | M10 | Vrac gencodé | 5 |

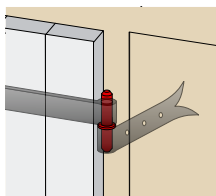
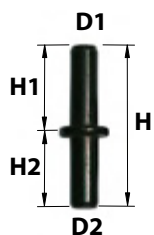

Axe de gond amovible

| Code | Gencod | | D1 | D2 | H | H1 | H2 | Type packaging | |
|---------|---------------|--|----|----|----|----|----|----------------|----|
| 0221904 | 3308182219041 | | 14 | 14 | 80 | 42 | 35 | Vrac gencodé | 10 |
| 0900901 | 3308189009010 | | 14 | 16 | 84 | 35 | 45 | Vrac gencodé | 10 |

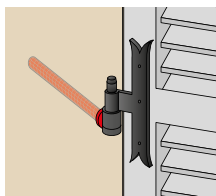
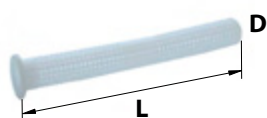

Tamis composite (x4)

| Code | Gencod | | D | L | Type packaging | |
|---------|---------------|--|----|-----|----------------|---|
| 0456000 | 3308184560004 | | 16 | 80 | Vrac gencodé | 5 |
| 0455900 | 3308184559008 | | 16 | 130 | Vrac gencodé | 5 |

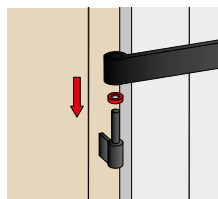
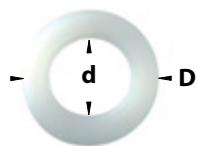

Rondelle composite (x10)

| Code | Gencod | | d | D | Ep. | Type packaging | | |
|---------|---------------|--|----------------------|----|-----|----------------|-------------------|----|
| 0952000 | 3308189520003 | | <input type="text"/> | 14 | 25 | 3 | Brochable gencodé | 1 |
| 0952100 | 3308189521000 | | <input type="text"/> | 16 | 27 | 3 | Brochable gencodé | 1 |
| 0418100 | 3308184181001 | | <input type="text"/> | 14 | 25 | 3 | | 30 |

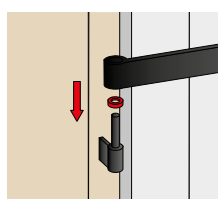
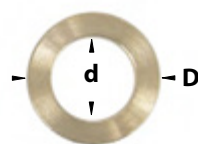

Rondelle laiton (x4)

| Code | Gencod | | d | D | Ep. | Type packaging | | |
|---------|---------------|--------|----------------------|----|-----|----------------|-------------------|---|
| 0953900 | 3308189539005 | LAITON | <input type="text"/> | 14 | 25 | 3 | Brochable gencodé | 1 |
| 0954000 | 3308189540001 | LAITON | <input type="text"/> | 16 | 27 | 3 | Brochable gencodé | 1 |

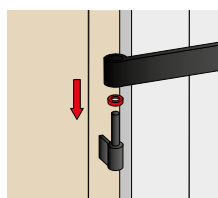
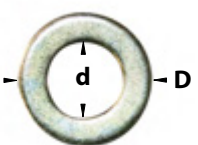

Rondelle acier (x4)

| Code | Gencod | | d | D | Ep. | Type packaging | | |
|---------|---------------|---------|----------------------|----|-----|----------------|-------------------|---|
| 0953703 | 3308189537032 | Z.BLANC | <input type="text"/> | 14 | 25 | 3 | Brochable gencodé | 1 |
| 0953803 | 3308189538039 | Z.BLANC | <input type="text"/> | 16 | 27 | 3 | Brochable gencodé | 1 |

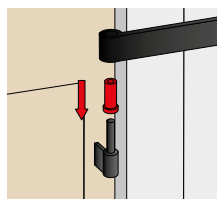

Convertisseur gond

| Code | Gencod | | d | D | L | Type packaging | |
|-----------|---------------|--|----|----|------|-------------------|----|
| x2 | | | | | | | |
| 0953600 | 3308189536004 | | 12 | 14 | 40,5 | Brochable gencodé | 1 |
| 0953500 | 3308189535007 | | 14 | 16 | 40,5 | Brochable gencodé | 1 |
| x4 | | | | | | | |
| 0418000 | 3308184180004 | | 14 | 16 | 40,5 | | 15 |

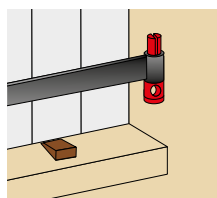

Gabarit de perçage pour gond à scellement chimique

| Code | Gencod | | Type packaging | |
|---------|---------------|--|-------------------|---|
| 0963400 | 3308189634007 | | Brochable gencodé | 1 |

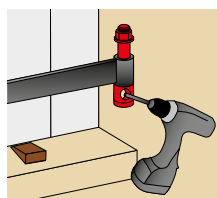

Gabarit de perçage acier pour gond à scellement chimique

| Code | Gencod | | Type packaging | |
|---------|---------------|---------|-------------------|---|
| 0109503 | 3308181095035 | Z.BLANC | Brochable gencodé | 1 |

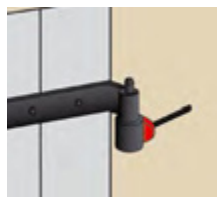

Bague de propreté pour gond

| Code | Gencod | | Type packaging | |
|---------|---------------|--|----------------|---|
| 0960000 | 3308189600002 | | Sachet gencodé | 5 |
| 0959900 | 3308189599009 | | Sachet gencodé | 5 |



La mise en œuvre des fermetures est encadrée par le DTU 34-4, s'y référer pour éviter tout danger.

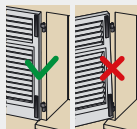

Bien s'assurer que le vantail soit monté plaqué et serré sur la façade.



En cas de vent, fermer les volets.



Pour les volets de grandes tailles, utiliser uniquement les arrêts adaptés



Conseils de pose P.133



Plus d'infos sur www.afbat.com

Tourniquet marseillais à vis bois *

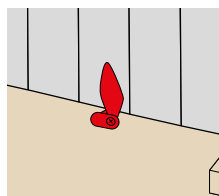
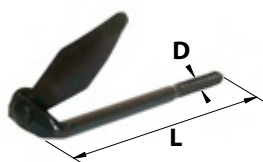

| Code | Gencod | | D | L | Type packaging | |
|---------|---------------|---------|----|-----|----------------|----|
| 0281201 | 3308182812013 | | 10 | 110 | Vrac gencodé | |
| 0222901 | 3308182229019 | | 10 | 130 | Vrac gencodé | |
| 0281301 | 3308182813010 | | 10 | 180 | Vrac gencodé | |
| 0417501 | 3308184175017 | | 10 | 250 | Vrac gencodé | |
| 0281203 | 3308182812037 | Z.BLANC | 10 | 110 | Vrac gencodé | |
| 0222903 | 3308182229033 | Z.BLANC | 10 | 130 | Vrac gencodé | |
| 0281303 | 3308182813034 | Z.BLANC | 10 | 180 | Vrac gencodé | |
| 0249001 | 3308182490013 | | 10 | 110 | | 50 |
| 0426701 | 3308184267019 | | 10 | 180 | | 20 |
| 0425901 | 3308184259014 | | 10 | 130 | | 30 |
| 0426701 | 3308184267019 | | 10 | 180 | | 20 |
| 0426001 | 3308184260010 | | 10 | 110 | | 30 |

Tourniquet marseillais à vis + cheville *

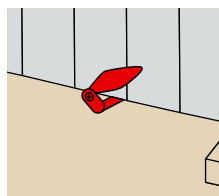

| Code | Gencod | | D | L | Type packaging | |
|---------|---------------|---------|----|-----|----------------|----|
| 0442304 | 3308184423040 | | 8 | 115 | Vrac gencodé | |
| 0442303 | 3308184423033 | Z.BLANC | 10 | 115 | Vrac gencodé | |
| 0249301 | 3308182493014 | | 8 | 115 | | 30 |

Tourniquet marseillais sur platine à visser *

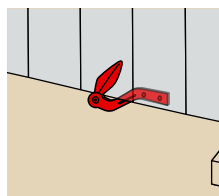
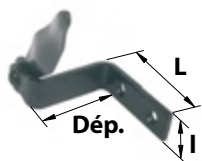

| Code | Gencod | | L | I | Ep. | Déport | Type packaging | |
|---------|---------------|---------|----|----|-----|--------|----------------|---|
| 0238001 | 3308182380017 | | 50 | 20 | 3,5 | 47 | Vrac gencodé | 5 |
| 0238003 | 3308182380031 | Z.BLANC | 50 | 20 | 3,5 | 47 | Vrac gencodé | 5 |

Arrêts de volet sur platine

(*)



La mise en œuvre des fermetures est encadrée par le DTU 34-4, s'y référer pour éviter tout danger.

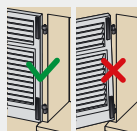

Bien s'assurer que le vantail soit monté plaqué et serré sur la façade.



En cas de vent, fermer les volets.



Pour les volets de grandes tailles, utiliser uniquement les arrêts adaptés



Conseils de pose P.133



Plus d'infos sur www.afbat.com



Dép.

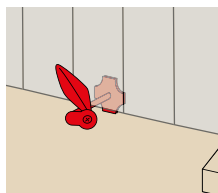

Tourniquet marseillais sur platine à visser *

| Code | Gencod | | Déport | Type packaging | |
|--------|---------------|--|--------|----------------|---|
| 520350 | 3479045203504 | | 40 | Vrac gencodé | 5 |
| 520355 | 3479045203559 | | 70 | Vrac gencodé | 5 |

Arrêts de volet à sceller

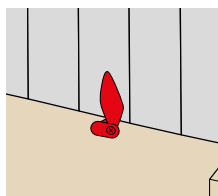
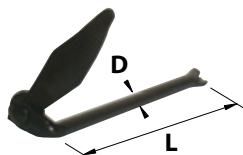

Tourniquet marseillais à sceller *

| Code | Gencod | | D | L | Type packaging | |
|---------|---------------|---------|----|-----|----------------|---|
| 0804601 | 3308188046016 | | 10 | 130 | Vrac gencodé | 5 |
| 0804701 | 3308188047013 | | 10 | 175 | Vrac gencodé | 5 |
| 0804603 | 3308180038163 | Z.BLANC | 10 | 130 | Vrac gencodé | 5 |
| 0804703 | 3308180038712 | Z.BLANC | 10 | 175 | Vrac gencodé | 5 |

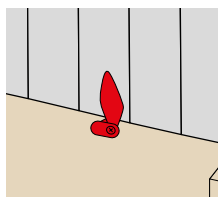
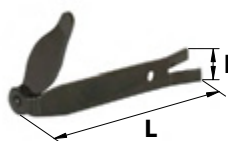

Tourniquet marseillais plat à sceller *

| Code | Gencod | | L | I | Ep. | Type packaging | |
|---------|---------------|--|-----|----|-----|----------------|----|
| 0248601 | 3308182486016 | | 125 | 20 | 3,5 | | 30 |



La mise en œuvre des fermetures est encadrée par le DTU 34-4, s'y référer pour éviter tout danger.

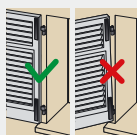

Bien s'assurer que le vantail soit monté plaqué et serré sur la façade.



En cas de vent, fermer les volets.



Pour les volets de grandes tailles, utiliser uniquement les arrêts adaptés



Conseils de pose P.133



Plus d'infos sur www.afbat.com

Arrêt tête bergère à visser *

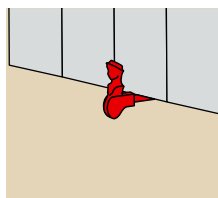
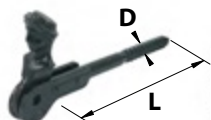

| Code | Gencod | | D | L | Type packaging | |
|---------|---------------|--|----|-----|----------------|----|
| 0724001 | 3308187240019 | | 10 | 115 | Vrac gencodé | 5 |
| 0724701 | 3308187247018 | | 10 | 155 | Vrac gencodé | 5 |
| 0249501 | 3308182495018 | | 10 | 115 | | 50 |
| 0259801 | 3308182598016 | | 10 | 155 | | 20 |

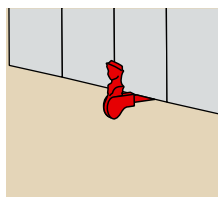
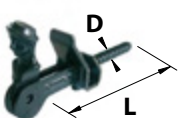

Arrêt tête bergère à visser + butée *

| Code | Gencod | | D | L | Type packaging | |
|---------|---------------|--|----|-----|----------------|---|
| 0724901 | 3308187249012 | | 10 | 115 | Vrac gencodé | 5 |

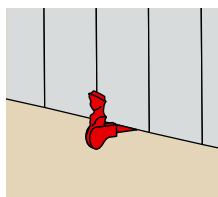

Arrêt tête bergère sur platine à visser *

| Code | Gencod | | Déport | Type packaging | |
|---------|---------------|--|--------|----------------|---|
| 0900701 | 3308189007016 | | 35 | Vrac gencodé | 5 |

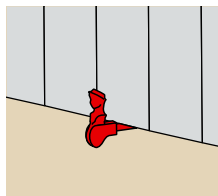
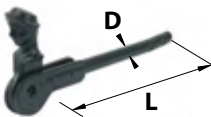

Arrêt tête bergère à sceller *

| Code | Gencod | | D | L | Type packaging | |
|---------|---------------|--|----|-----|----------------|---|
| 0723901 | 3308187239013 | | 10 | 135 | Vrac gencodé | 5 |

Butées d'arrêts de volet

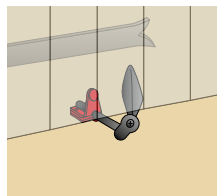
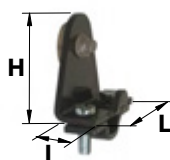

Butée universelle pour tourniquet marseillais

| Code | Gencod | | L | I | H | Ep. | Type packaging | |
|------------------------|---------------|---------|----|------|----|-----|-------------------|----|
| Sachet 2 unités | | | | | | | | |
| 0956501 | 3308189565011 | | 41 | 17,5 | 41 | 2,5 | Brochable gencodé | 2 |
| Sachet unitaire | | | | | | | | |
| 0198704 | 3308181987040 | | 38 | 17,5 | 39 | 2,5 | Vrac gencodé | 1 |
| 0198703 | 3308180038873 | Z.BLANC | 38 | 17,5 | 39 | 2,5 | Vrac gencodé | 1 |
| 0432304 | 3308184323043 | | 41 | 17,5 | 41 | 2,5 | | 50 |

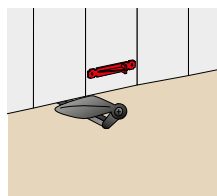

Protecteur de volet composite (x2)

| Code | Gencod | | L | I | H | Type packaging | |
|---------|---------------|--|----|----|----|-------------------|---|
| 0953000 | 3308189530002 | | 70 | 15 | 12 | Brochable gencodé | 1 |

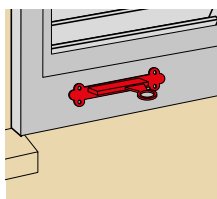

Arrêt de volet à ressort autobloquant

| Code | Gencod | | L | I | H | Ep. | Type packaging | | |
|---------|---------------|--|-----|----|----|-----|-------------------|--|----|
| 0954801 | 3308189548014 | | 148 | 38 | 50 | 2 | Brochable gencodé | | 1 |
| 0941501 | 3308189415019 | | 148 | 38 | 50 | 2 | | | 10 |



La mise en œuvre des fermetures est encadrée par le DTU 34-4, s'y référer pour éviter tout danger.

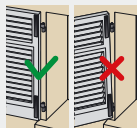

Bien s'assurer que le vantail soit monté plaqué et serré sur la façade.



En cas de vent, fermer les volets.



Pour les volets de grandes tailles, utiliser uniquement les arrêts adaptés



Conseils de pose P.133



Plus d'infos sur www.afbat.com

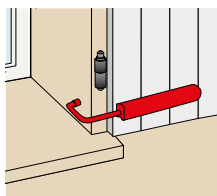
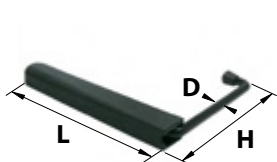

Arrêt de volet Verouilvolet (x2)

| Code | Gencod | | D | L | H | Type packaging | | |
|---------|---------------|--|----|-----|-----|-------------------|--|---|
| 0952400 | 3308189524001 | | 12 | 250 | 135 | Brochable gencodé | | 1 |
| 0958500 | 3308189585002 | | 12 | 250 | 135 | Brochable gencodé | | 1 |



La mise en œuvre des fermetures est encadrée par le DTU 34-4, s'y référer pour éviter tout danger.



Surface maximum 1 m² par vantail.



Largeur maximum du volet : 500 mm.



Ne pas utiliser en zone venteuse.



En cas de vent, fermer les volets.



Utiliser tous les trous de fixation prévus à cet effet (5) pour fixer la pièce.



Vérifier le serrage régulièrement.



Conseils de pose P.133



Plus d'infos sur www.afbat.com

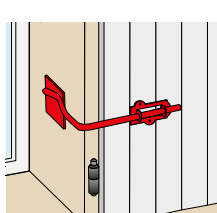
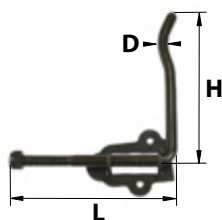

Arrêt de volet à poignée (x2)

| Code | Gencod | | D | L | H | Type packaging | | |
|---------|---------------|--|----|-----|-----|-------------------|--|---|
| 0956704 | 3308189567046 | | 12 | 167 | 174 | Brochable gencodé | | 1 |
| 0956626 | 3308189566261 | | 12 | 167 | 174 | Brochable gencodé | | 1 |
| 0932601 | 3308189326018 | | 12 | 167 | 174 | | | 4 |



La mise en œuvre des fermetures est encadrée par le DTU 34-4, s'y référer pour éviter tout danger.



Surface maximum 1 m² par vantail.



Largeur maximum du volet : 500 mm.



Ne pas utiliser en zone venteuse.



En cas de vent, fermer les volets.



Utiliser tous les trous de fixation prévus à cet effet (2+2) pour fixer la pièce.



Vérifier le serrage régulièrement.



Conseils de pose P.133



Plus d'infos sur www.afbat.com

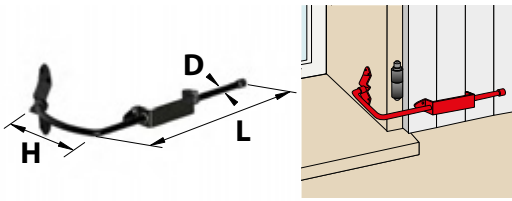

Arrêt de volet Bloc Boy

| Code | Gencod | | D | L | H | Type packaging | |
|---------|---------------|--|----|-----|-----|-------------------|---|
| 0994800 | 3308189948005 | | 14 | 414 | 188 | Brochable gencodé | 1 |
| 0994900 | 3308189949002 | | 14 | 414 | 188 | Brochable gencodé | 1 |

La mise en œuvre des fermetures est encadrée par le DTU 34-4, s'y référer pour éviter tout danger.

Surface maximum 1,5 m² par vantail.

Poids maximum 20 kg par vantail

Ne pas utiliser en zone venteuse.

En cas de vent, fermer les volets.

Utiliser tous les trous de fixation prévus à cet effet (4+4) pour fixer la pièce.

Vérifier le serrage régulièrement.

Conseils de pose P.133

Plus d'infos sur www.afbat.com

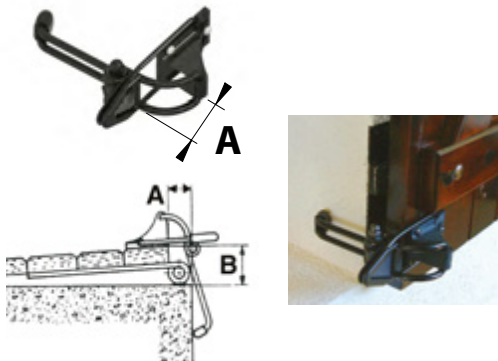

Arrêt BlocVolet

| Code | Gencod | | A | B | Type packaging | |
|--------|---------------|--|-----------|-----------|-------------------|---|
| 152060 | 3332061520607 | | <ou= 3 cm | <ou= 9 cm | Brochable gencodé | 1 |

La mise en œuvre des fermetures est encadrée par le DTU 34-4, s'y référer pour éviter tout danger.

Surface maximum 1 m² par vantail.

Poids maximum 20 kg par vantail

Ne pas utiliser en zone venteuse.

En cas de vent, fermer les volets.

Utiliser tous les trous de fixation prévus à cet effet (3) pour fixer la pièce.

Vérifier le serrage régulièrement.

Conseils de pose P.133

Plus d'infos sur www.afbat.com

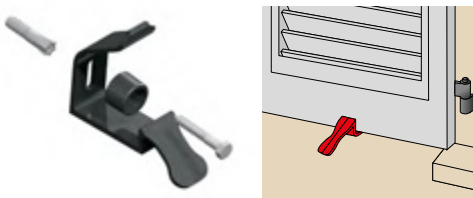

Arrêt StopVolet (x 2)

| Code | Gencod | | Type packaging | |
|---|---------------|--|----------------|----|
| Epaisseur de volet de 20 à 35 mm | | | | |
| 151050 | 3332061510509 | | Vrac gencodé | 10 |
| 621430 | 3332061511308 | | Vrac gencodé | 10 |

La mise en œuvre des fermetures est encadrée par le DTU 34-4, s'y référer pour éviter tout danger.

Bien s'assurer que le vantail soit monté plaqué et serré sur la façade.

En cas de vent, fermer les volets.

Pour les volets de grandes tailles, utiliser uniquement les arrêts adaptés

Conseils de pose P.133

Plus d'infos sur www.afbat.com

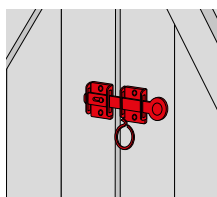
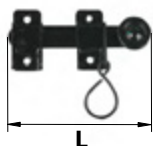

Fermeture de volet + support

| Code | Gencod | | L | Type packaging | |
|---------|---------------|--|-----|----------------|----|
| 0273201 | 3308182732014 | | 130 | Vrac gencodé | 5 |
| 0941901 | 3308189419017 | | 130 | | 20 |

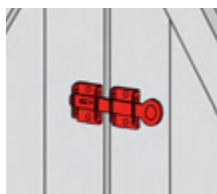

Poignée fléau à blocage + support

| Code | Gencod | | L | Type packaging | |
|---------|---------------|---------|-----|----------------|---|
| 529202 | 3479045292027 | | 160 | Vrac gencodé | 5 |
| 529183 | 3479045291839 | Z.BLANC | 160 | Vrac gencodé | 5 |
| 9529203 | 3479045292034 | | 190 | Vrac gencodé | 5 |
| 529181 | 3479045291815 | Z.BLANC | 190 | Vrac gencodé | 5 |

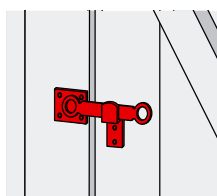
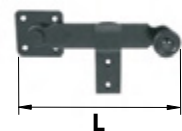

Poignée fléau + support

| Code | Gencod | | L | Type packaging | |
|---------|---------------|---------|-----|----------------|----|
| 0812701 | 3308188127012 | | 140 | Vrac gencodé | 10 |
| 0812901 | 3308188129016 | | 160 | Vrac gencodé | 10 |
| 0813001 | 3308188130012 | | 190 | Vrac gencodé | 10 |
| 0812703 | 3308180038552 | Z.BLANC | 140 | Vrac gencodé | 10 |
| 0812903 | 3308180038569 | Z.BLANC | 160 | Vrac gencodé | 10 |
| 0813003 | 3308180038576 | Z.BLANC | 190 | Vrac gencodé | 10 |
| 0941801 | 3308189418010 | | 140 | | 20 |
| 0246302 | 3308182463024 | Z.BLANC | 140 | | 20 |
| 0246402 | 3308182464021 | Z.BLANC | 190 | | 20 |

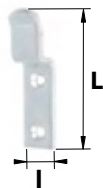

Agrafe volet nord coudée

| Code | Gencod | | L | I | Ep. | Type packaging | |
|---------|---------------|---------|----|----|-----|----------------|---|
| 6104009 | 3221686104005 | Z.BLANC | 75 | 18 | 3 | Vrac gencodé | 5 |

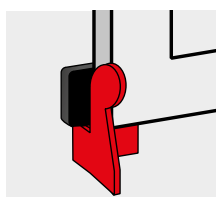

Agrafe picarde coudée

| Code | Gencod | | L | I | Ep. | Type packaging | |
|----------------------|---------------|---------|----|----|-----|----------------|---|
| Modèle droite | | | | | | | |
| 6106134 | 3221686106139 | Z.BLANC | 35 | 18 | 3 | Vrac gencodé | 5 |
| Modèle gauche | | | | | | | |
| 6106234 | 3221686106238 | Z.BLANC | 35 | 18 | 3 | Vrac gencodé | 5 |

Modèle droite

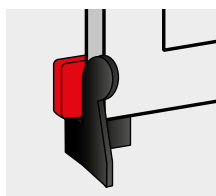
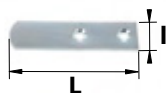

Panneton droit

| Code | Gencod | | L | I | Ep. | Type packaging | |
|---------|---------------|---------|----|----|-----|----------------|---|
| 6103075 | 3221686103077 | Z.BLANC | 75 | 18 | 3 | Vrac gencodé | 5 |

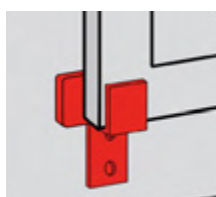

Panneton + agrafe

| Code | Gencod | | Type packaging | |
|--|---------------|---------|-------------------|---|
| Panneton + agrafe nord coudée (x4) | | | | |
| 0544175 | 3221680544173 | | Vrac gencodé | 1 |
| 0144175 | 3221680144175 | Z.BLANC | Vrac gencodé | 1 |
| Panneton + agrafe picarde (2 droite + 2 gauche) | | | | |
| 0953302 | 3308189533027 | Z.BLANC | Brochable gencodé | 1 |

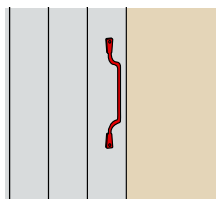
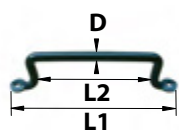

Poignée fil à pattes

| Code | Gencod | | D | L1 | L2 | Type packaging | |
|---------|---------------|---------|----|-----|-----|----------------|----|
| 9158085 | 3221689158081 | | 8 | 140 | 85 | Vrac gencodé | 10 |
| 0357804 | 3308183578048 | | 8 | 165 | 95 | Vrac gencodé | 10 |
| 0502104 | 3308185021047 | | 10 | 160 | 105 | Vrac gencodé | 10 |
| 7158085 | 3221687158083 | Z.BLANC | 8 | 140 | 85 | Vrac gencodé | 10 |
| 6158100 | 3221686158107 | Z.BLANC | 8 | 165 | 95 | Vrac gencodé | 10 |
| 0502102 | 3308185021023 | Z.BLANC | 10 | 160 | 105 | Vrac gencodé | 10 |
| 0258201 | 3308182582015 | | 8 | 165 | 95 | | 50 |
| 0258202 | 3308182582022 | Z.BLANC | 8 | 165 | 95 | | 50 |

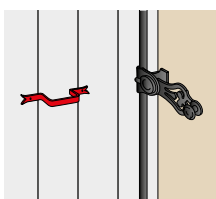
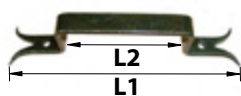

Poignée à pattes queue de carpe

| Code | Gencod | | L1 | L2 | Type packaging | |
|---------|---------------|--|-----|----|----------------|----|
| 9115085 | 3221689115084 | | 175 | 85 | Vrac gencodé | 10 |

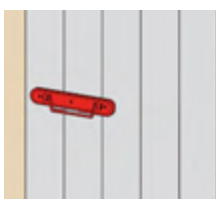

Poignée sur platine bouts ronds

| Code | Gencod | | L | Type packaging | |
|---------|---------------|---------|-----|----------------|----|
| 8149014 | 3221688149141 | | 140 | Vrac gencodé | 10 |
| 8149016 | 3221688149165 | | 160 | Vrac gencodé | 10 |
| 8149019 | 3221688149196 | | 190 | Vrac gencodé | 10 |
| 6149014 | 3221686149143 | Z.BLANC | 140 | Vrac gencodé | 10 |
| 6149016 | 3221686149167 | Z.BLANC | 160 | Vrac gencodé | 10 |
| 6149019 | 3221686149198 | Z.BLANC | 190 | Vrac gencodé | 10 |

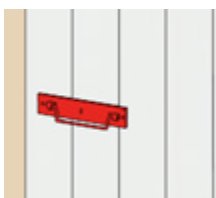

Poignée sur platine bouts carrés

| Code | Gencod | | L | Type packaging | |
|---------|---------------|---------|-----|----------------|----|
| 8150012 | 3221688150123 | | 120 | Vrac gencodé | 10 |
| 8150014 | 3221688150147 | | 140 | Vrac gencodé | 10 |
| 8150016 | 3221688150161 | | 160 | Vrac gencodé | 10 |
| 8150019 | 3221688150192 | | 190 | Vrac gencodé | 10 |
| 0491303 | 3308184913039 | Z.BLANC | 120 | Vrac gencodé | 10 |
| 0724103 | 3308187241030 | Z.BLANC | 140 | Vrac gencodé | 10 |
| 7150016 | 3221687150162 | Z.BLANC | 160 | Vrac gencodé | 10 |
| 7150019 | 3221687150193 | Z.BLANC | 190 | Vrac gencodé | 10 |
| 0246504 | 3308182465042 | | 140 | | 30 |
| 0246503 | 3308182465035 | Z.BLANC | 140 | | 30 |

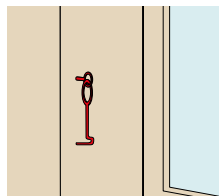
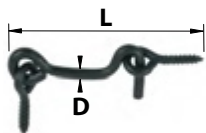

Crochet de contrevent + pitons

| Code | Gencod | | D | L | Type packaging | |
|---------------------------|---------------|---------|---|-----|----------------|-----|
| 8177005 | 3221688177007 | | 4 | 50 | Vrac gencodé | 10 |
| 8177060 | 3221688177069 | | 4 | 60 | Vrac gencodé | 10 |
| 8177080 | 3221688177083 | | 4 | 80 | Vrac gencodé | 10 |
| 6177005 | 3221686177009 | Z.BLANC | 4 | 50 | Vrac gencodé | 10 |
| 6177060 | 3221686177061 | Z.BLANC | 4 | 60 | Vrac gencodé | 10 |
| 6177080 | 3221686177085 | Z.BLANC | 4 | 80 | Vrac gencodé | 10 |
| 8177100 | 3221688177106 | | 5 | 100 | Vrac gencodé | 10 |
| 8177120 | 3221688177120 | | 5 | 120 | Vrac gencodé | 10 |
| 6177100 | 3221686177108 | Z.BLANC | 5 | 100 | Vrac gencodé | 10 |
| 6177120 | 3221686177122 | Z.BLANC | 5 | 120 | Vrac gencodé | 10 |
| 8177140 | 3221688177144 | | 6 | 140 | Vrac gencodé | 10 |
| 8177160 | 3221688177168 | | 6 | 160 | Vrac gencodé | 10 |
| 8177180 | 3221688177182 | | 6 | 180 | Vrac gencodé | 10 |
| 8177200 | 3221688177205 | | 6 | 200 | Vrac gencodé | 10 |
| 6177140 | 3221686177146 | Z.BLANC | 6 | 140 | Vrac gencodé | 10 |
| 6177160 | 3221686177160 | Z.BLANC | 6 | 160 | Vrac gencodé | 10 |
| 6177180 | 3221686177184 | Z.BLANC | 6 | 180 | Vrac gencodé | 10 |
| 6177200 | 3221686177207 | Z.BLANC | 6 | 200 | Vrac gencodé | 10 |
| 0494804 | 3308184948048 | | 8 | 300 | Vrac gencodé | 10 |
| 0494904 | 3308184949045 | | 8 | 400 | Vrac gencodé | 10 |
| 0495004 | 3308184950041 | | 8 | 500 | Vrac gencodé | 10 |
| 0494802 | 3308184948024 | Z.BLANC | 8 | 300 | Vrac gencodé | 10 |
| 0494902 | 3308184949021 | Z.BLANC | 8 | 400 | Vrac gencodé | 10 |
| 0495002 | 3308184950027 | Z.BLANC | 8 | 500 | Vrac gencodé | 10 |
| 0245402 | 3308182454022 | Z.BLANC | 4 | 50 | | 100 |
| 0245502 | 3308182455029 | Z.BLANC | 4 | 80 | | 100 |
| 0245602 | 3308182456026 | Z.BLANC | 5 | 100 | | 100 |
| 0245702 | 3308182457023 | Z.BLANC | 5 | 120 | | 50 |
| 0245802 | 3308182458020 | Z.BLANC | 6 | 140 | | 50 |
| 0245902 | 3308182459027 | Z.BLANC | 6 | 160 | | 50 |
| 0246002 | 3308182460023 | Z.BLANC | 6 | 180 | | 50 |
| 0246102 | 3308182461020 | Z.BLANC | 6 | 200 | | 50 |
| Sachet de 2 unités | | | | | | |
| 672305 | 3026726723051 | Z.BLANC | 8 | 60 | Vrac gencodé | |
| 672308 | 3026726723082 | Z.BLANC | 8 | 80 | Vrac gencodé | |
| 672310 | 3026726723105 | Z.BLANC | 8 | 100 | Vrac gencodé | |
| 672314 | 3026726723143 | Z.BLANC | 8 | 140 | Vrac gencodé | |
| 672316 | 3026726723167 | Z.BLANC | 8 | 160 | Vrac gencodé | |

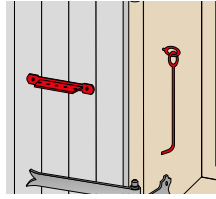

Crochet + crémaillère à poignée

| Code | Gencod | | D | L | Type packaging | |
|---------|---------------|---------|---|-----|----------------|----|
| 0491104 | 3308180038897 | | 8 | 300 | Vrac gencodé | 10 |
| 503496 | 3479045034962 | | 8 | 350 | Vrac gencodé | 10 |
| 0491004 | 3308180038910 | | 8 | 400 | Vrac gencodé | 10 |
| 0812404 | 3308180038521 | | 8 | 500 | Vrac gencodé | 10 |
| 503500 | 3479045035006 | | 8 | 600 | Vrac gencodé | 10 |
| 0491103 | 3308184911035 | Z.BLANC | 8 | 300 | Vrac gencodé | 10 |
| 503476 | 3479045034764 | Z.BLANC | 8 | 350 | Vrac gencodé | 10 |
| 0491003 | 3308184910038 | Z.BLANC | 8 | 400 | Vrac gencodé | 10 |
| 0812403 | 3308180038514 | Z.BLANC | 8 | 500 | Vrac gencodé | 10 |
| 503480 | 3479045034801 | Z.BLANC | 8 | 600 | Vrac gencodé | 10 |
| 0464604 | 3308184646043 | | 8 | 300 | | 40 |
| 0465004 | 3308184650040 | | 8 | 400 | | 25 |

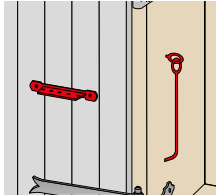
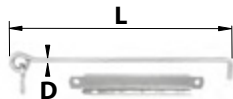

Crochet + crémaillère L

| Code | Gencod | | D | L | Type packaging | |
|---------|---------------|---------|---|-----|----------------|----|
| 0288002 | 3308182880029 | Z.BLANC | 8 | 300 | | 20 |
| 0466102 | 3308184661022 | Z.BLANC | 8 | 400 | | 20 |
| 0466202 | 3308184662029 | Z.BLANC | 8 | 500 | | 20 |

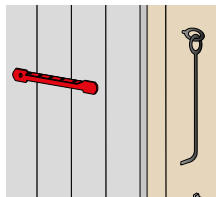
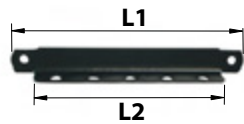

Crémaillère L

| Code | Gencod | | L1 | L2 | Ep. | Type packaging | |
|---------|---------------|--|-----|-----|-----|----------------|---|
| 0362501 | 3308183625018 | | 190 | 155 | 2 | Vrac gencodé | 1 |

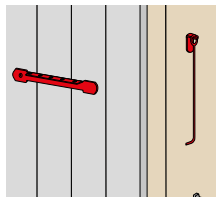
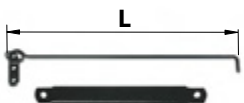

Crochet sur platine + crémaillère L

| Code | Gencod | | D | L | Type packaging | |
|---------|---------------|--|---|-----|----------------|---|
| 0963001 | 3308189630016 | | 8 | 300 | Vrac gencodé | 5 |
| 0963101 | 3308189631013 | | 8 | 400 | Vrac gencodé | 5 |

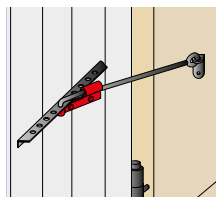

Verrou antisoulèvement pour crochet de volet

| Code | Gencod | | D | L | Type packaging | |
|---------|---------------|--|----|----|-------------------|---|
| 0958200 | 3308189582001 | | 10 | 97 | Brochable gencodé | 1 |

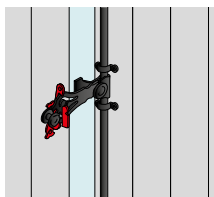

Support espagnolette antisoulèvement

| Code | Gencod | | Type packaging | |
|---------|---------------|--|-------------------|---|
| 0957801 | 3308189578011 | | Brochable gencodé | 1 |

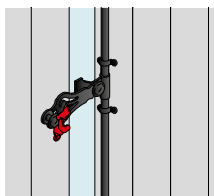

Support espagnolette verrou

| Code | Gencod | | Type packaging | |
|---------|---------------|--|-------------------|---|
| 0957904 | 3308189579049 | | Brochable gencodé | 1 |

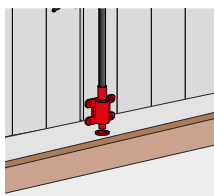

Modèle bas

Verrou espagnolette

| Code | Gencod | | Type packaging | |
|--------------------|---------------|--|-------------------|---|
| Modèle Bas | | | | |
| 0958300 | 3308189583008 | | Brochable gencodé | 1 |
| Modèle Haut | | | | |
| 0964800 | 3308189648004 | | Brochable gencodé | 1 |

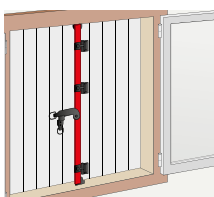

Tringle pour espagnolette plate acier

| Code | Gencod | | L | I | Ep. | Type packaging | |
|--------|---------------|--|------|----|-----|----------------|---|
| 620651 | 3479046206511 | | 1500 | 25 | 4 | Vrac gencodé | 1 |
| 620653 | 3479046206535 | | 2500 | 25 | 4 | Vrac gencodé | 1 |

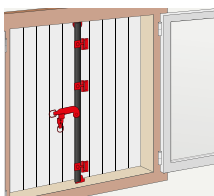

Accessoires espagnolette plate acier

| Code | Gencod | | Type packaging | |
|--------|---------------|--|-------------------|---|
| 620632 | 3221686206327 | | Brochable gencodé | 1 |

Composition
3 coulisseaux
1 support de loquet

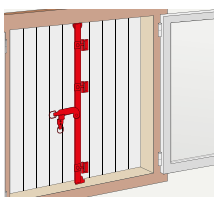

Kit complet espagnolette plate

| Code | Gencod | | L | I | Ep. | Type packaging | |
|---------|---------------|--|------|----|-----|----------------|---|
| 0703204 | 3308187032041 | | 1500 | 25 | 4 | Vrac gencodé | 1 |
| 0703304 | 3308187033048 | | 2400 | 25 | 4 | Vrac gencodé | 1 |

Composition
1 tringle plate L1500 ou 2400 mm
1 butée haute + 1 butée basse
3 coulisseaux
1 support de loquet

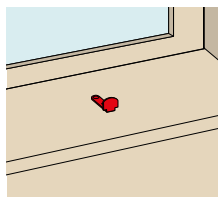
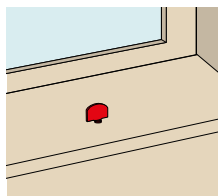
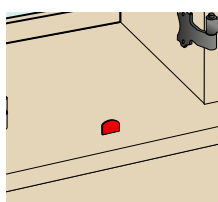
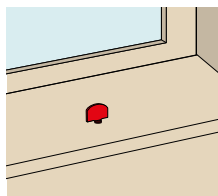
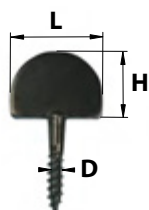

Butée droite à vis

| Code | Gencod | | D | L | H | Ep. | Type packaging | |
|---|---------------|---------|---|----|----|-----|-------------------|-----|
| 9251001 | 3221689251010 | | 6 | 57 | 25 | 3,5 | Vrac gencodé | 10 |
| 7251001 | 3221687251005 | Z.BLANC | 6 | 57 | 25 | 3,5 | Vrac gencodé | 10 |
| 0244301 | 3308182443019 | | 6 | 57 | 25 | 3,5 | | 100 |
| x2 | | | | | | | | |
| 0988001 | 3308189880015 | | 6 | 57 | 25 | 3,5 | Vrac gencodé | 5 |
| Butée droite à vis + à cheville (x2) | | | | | | | | |
| 0269401 | 3308182694015 | | 6 | 57 | 25 | 3,5 | Brochable gencodé | 1 |

Butée coudée à vis

| Code | Gencod | | D | L | H | Ep. | Déport | Type packaging | |
|---------|---------------|---------|---|----|----|-----|--------|----------------|-----|
| 0544404 | 3308185444044 | | 6 | 37 | 27 | 3 | 36 | Vrac gencodé | 10 |
| 0988201 | 3308189882019 | | 6 | 37 | 27 | 3 | 36 | Vrac gencodé | 5 |
| 7351011 | 3221687351019 | Z.BLANC | 6 | 37 | 27 | 3 | 36 | Vrac gencodé | 10 |
| 0244101 | 3308182441015 | | 6 | 37 | 27 | 3 | 36 | | 100 |

Kit butée à vis 1 droite + 1 coudée + 2 chevilles

| Code | Gencod | | Type packaging | |
|--------|---------------|--|-------------------|----|
| 538055 | 3221685380554 | | Brochable gencodé | 10 |

Butée coudée ronde à visser

| Code | Gencod | | H | Ep. | Déport | Type packaging | |
|---------|---------------|---------|----|-----|--------|----------------|----|
| 9351600 | 3221689351604 | | 25 | 3 | 30 | Vrac gencodé | 10 |
| 7351600 | 3221687351606 | Z.BLANC | 25 | 3 | 30 | Vrac gencodé | 10 |

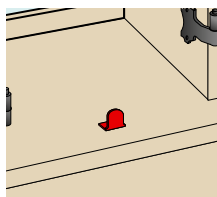
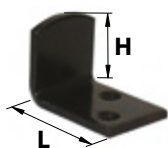

Butée coudée à visser

| Code | Gencod | | L | H | Ep. | Type packaging | |
|---------|---------------|---------|----|----|-----|----------------|----|
| 4239034 | 3221684139030 | | 44 | 25 | 4 | Vrac gencodé | 10 |
| 7239034 | 3221687239034 | Z.BLANC | 44 | 25 | 4 | Vrac gencodé | 10 |

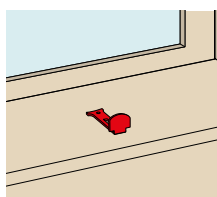
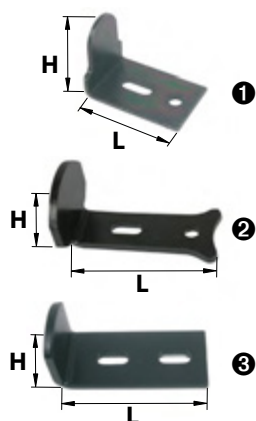

Butée coudée réglable à visser

| Code | Gencod | | L | H | Ep. | Type packaging | | |
|------------------------------------|---------|---------------|---------|----|-----|----------------|--------------|----|
| 1 trou rond + 1 trou oblong | | | | | | | | |
| ① | 620099 | 3479046200991 | | 47 | 35 | 2,5 | Vrac gencodé | 10 |
| ② | 602040 | 3221686020404 | | 63 | 35 | 3 | Vrac gencodé | 10 |
| ② | 0942904 | 3308189429047 | | 63 | 35 | 3 | | 50 |
| 2 trous oblongs | | | | | | | | |
| ③ | 4172034 | 3221684172037 | | 69 | 30 | 4 | Vrac gencodé | 10 |
| ③ | 7172034 | 3221687172034 | Z.BLANC | 69 | 30 | 4 | Vrac gencodé | 10 |

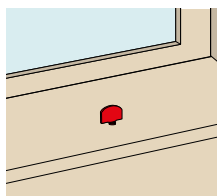

Butée droite à sceller

| Code | Gencod | | L | H | Ep. | Type packaging | |
|---------|---------------|---------|----|----|-----|----------------|----|
| 0408404 | 3308184084043 | | 60 | 25 | 4 | Vrac gencodé | 10 |
| 0408403 | 3308184084036 | Z.BLANC | 60 | 25 | 4 | Vrac gencodé | 10 |

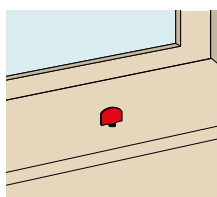
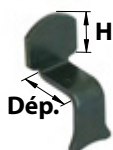

Butée coudée à sceller

| Code | Gencod | | H | Ep. | Déport | Type packaging | |
|---------|---------------|--|----|-----|--------|----------------|----|
| 9151011 | 3221689151013 | | 25 | 3 | 32 | Vrac gencodé | 10 |

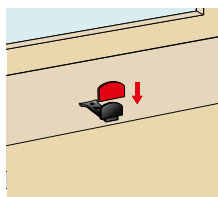
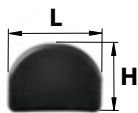

Protecteur tête de butée composite (x2)

| Code | Gencod | | L | H | Type packaging | |
|---------|---------------|--|----|----|-------------------|---|
| 0952900 | 3308189529006 | | 43 | 33 | Brochable gencodé | 1 |

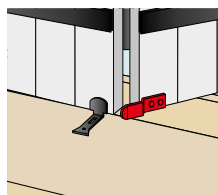
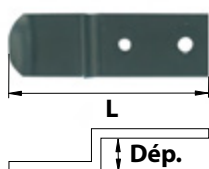

Crochet de rappel (x2)

| Code | Gencod | | L | Ep. | Déport | Type packaging | |
|---------|---------------|--|----|-----|--------|-------------------|----|
| 0952604 | 3308189526043 | | 70 | 2,5 | 10 | Brochable gencodé | 1 |
| 0261501 | 3308182615010 | | 70 | 2,5 | 10 | | 20 |

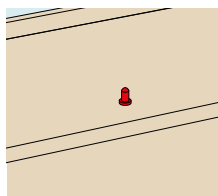

Goujon espagnolette

| Code | Gencod | | ØD | Ød | H | Type packaging | |
|--|---------------|--|----|----|----|-------------------|---|
| Droit à visser | | | | | | | |
| 0963701 | 3308189637015 | | 10 | 7 | 65 | Vrac gencodé | 1 |
| Droit à visser (x2) + chevilles (x2) | | | | | | | |
| 0269601 | 3308182696019 | | 10 | 7 | 65 | Brochable gencodé | 1 |
| Goujon droit (x1) + coudé (x1) + chevilles (x2) | | | | | | | |
| 620093 | 3221686200936 | | 10 | 7 | 65 | Brochable gencodé | 1 |

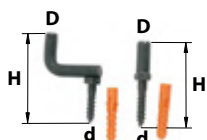



L'EXTÉRIEUR DE L'HABITAT

LE VOLET ALU & PVC

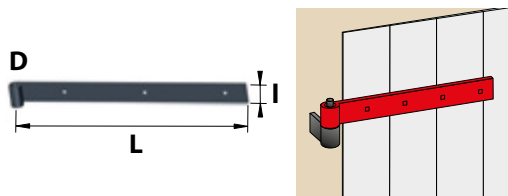

Penture aluminium bout droit

| Code | Gencod | | D | L | I | Ep. | Type packaging | |
|---------|---------------|--|----|-----|----|-----|----------------|---|
| 1401415 | 3308181401416 | | 14 | 415 | 39 | 4 | Vrac gencodé | 4 |
| 1401560 | 3308181401560 | | 14 | 560 | 39 | 4 | Vrac gencodé | 4 |

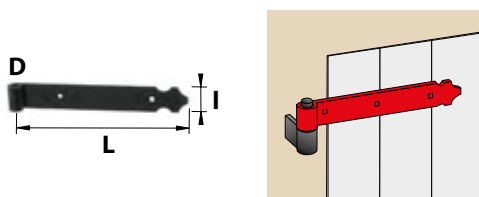

Penture aluminium bout feston

| Code | Gencod | | D | L | I | Ep. | Type packaging | |
|---------|---------------|--|----|-----|----|-----|----------------|---|
| 1403415 | 3308181403410 | | 14 | 415 | 39 | 4 | Vrac gencodé | 4 |
| 1403560 | 3308181403564 | | 14 | 560 | 39 | 4 | Vrac gencodé | 4 |

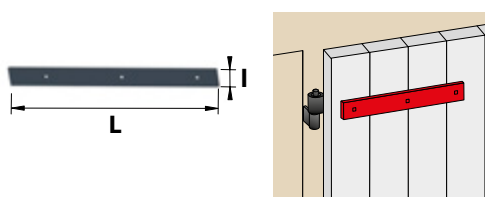

Contre-penture aluminium bout droit

| Code | Gencod | | L | I | Ep. | Type packaging | |
|---------|---------------|--|-----|----|-----|----------------|---|
| 1402355 | 3308181402352 | | 355 | 39 | 3 | Vrac gencodé | 4 |
| 1402500 | 3308181402505 | | 500 | 39 | 3 | Vrac gencodé | 4 |

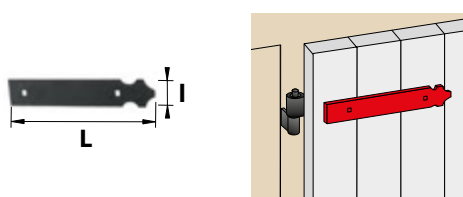

Contre-penture aluminium bout feston

| Code | Gencod | | L | I | Ep. | Type packaging | |
|---------|---------------|--|-----|----|-----|----------------|---|
| 1404370 | 3308181404370 | | 370 | 39 | 2 | Vrac gencodé | 4 |
| 1404515 | 3308181404516 | | 515 | 39 | 2 | Vrac gencodé | 4 |

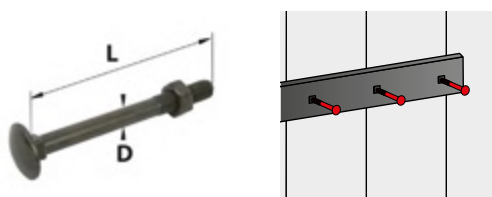

Boulon TRCC aluminium (x8)

| Code | Gencod | | D | L | Type packaging | |
|---------|---------------|--|---|----|-------------------|---|
| 1405645 | 3221684056450 | | 6 | 45 | Brochable gencodé | 1 |

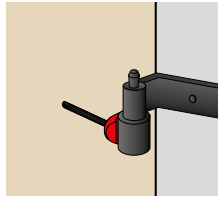

Bague de propreté pour gond

| Code | Gencod | | L | H | Type packaging | |
|---------|---------------|--|----|----|----------------|---|
| 0960000 | 3308189600002 | | 47 | 13 | Vrac gencodé | 5 |
| 0959900 | 3308189599009 | | 47 | 13 | Vrac gencodé | 5 |

Gonds

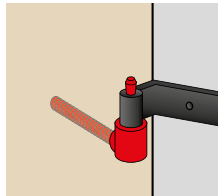
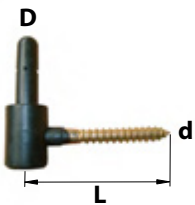

Gond à visser composite

| Code | Gencod | | D | d | L | Type packaging | |
|---------|---------------|--|----|----|----|----------------|---|
| 0214800 | 3308182148006 | | 14 | 10 | 95 | Vrac gencodé | 1 |
| 0645000 | 3308186450006 | | 14 | 10 | 95 | Vrac gencodé | 1 |

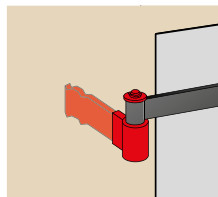
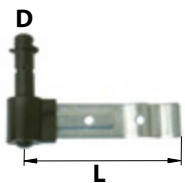

Gond à sceller composite

| Code | Gencod | | D | L | Type packaging | |
|---------|---------------|--|----|-----|----------------|---|
| 0214600 | 3308182146002 | | 14 | 115 | Vrac gencodé | 1 |
| 0591100 | 3308185911003 | | 14 | 115 | Vrac gencodé | 1 |

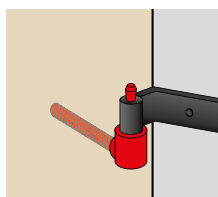
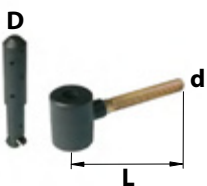

Gond à scellement chimique composite

| Code | Gencod | | D | d | L | Type packaging | |
|---------|---------------|--|----|-----|-----|----------------|---|
| 0215300 | 3308182153000 | | 14 | M10 | 135 | Vrac gencodé | 1 |
| 0661200 | 3308186612008 | | 14 | M10 | 135 | Vrac gencodé | 1 |

Arrêts de volets à visser



La mise en œuvre des fermetures est encadrée par le DTU 34-4, s'y référer pour éviter tout danger.

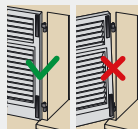

Bien s'assurer que le vantail soit monté plaqué et serré sur la façade.



En cas de vent, fermer les volets.



Pour les volets de grandes tailles, utiliser uniquement les arrêts adaptés



Conseils de pose P.133



Plus d'infos sur www.afbat.com

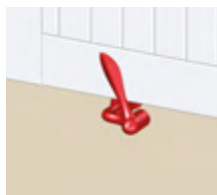
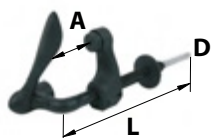

Tourniquet marseillais composite * Hélice à rouleau

| Code | Gencod | | D | L | A | Type packaging | | |
|---------|---------------|--|----|-----|-------|----------------|--|---|
| 0997300 | 3308189973007 | | 10 | 160 | 12/46 | Vrac gencodé | | 1 |
| 0997400 | 3308189974004 | | 10 | 160 | 12/46 | Vrac gencodé | | 1 |

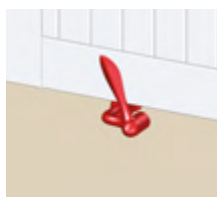
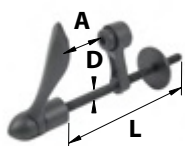

Tourniquet marseillais zamak * Hélice à rouleau

| Code | Gencod | | D | L | A | Type packaging | | |
|---------|---------------|--|----|-----|--------|----------------|--|---|
| 1010600 | 3308180106008 | | 10 | 165 | 12/60 | Vrac gencodé | | 1 |
| 1010700 | 3308180107005 | | 10 | 265 | 12/110 | Vrac gencodé | | 1 |

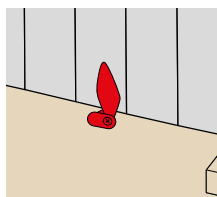
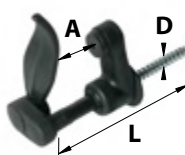

Tourniquet marseillais composite à visser S4000 *

| Code | Gencod | | D | L | A | Type packaging | | |
|---------|---------------|--|----|-----|--------|----------------|--|----|
| 0951700 | 3308189517003 | | 10 | 130 | 12/46 | Vrac gencodé | | 5 |
| 0951900 | 3308189519007 | | 10 | 200 | 12/116 | Vrac gencodé | | 5 |
| 0951600 | 3308189516006 | | 10 | 130 | 12/46 | Vrac gencodé | | 5 |
| 0951800 | 3308189518000 | | 10 | 200 | 12/116 | Vrac gencodé | | 5 |
| 0951750 | 3308189517508 | | 10 | 130 | 12/46 | | | 10 |

Arrêts tête de bergère à visser

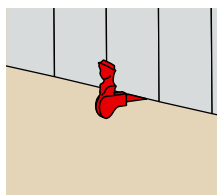
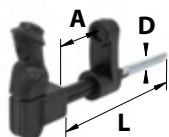

Arrêt tête bergère composite à visser S4000 *

| Code | Gencod | | D | L | A | Type packaging | | |
|--------|---------------|--|----|-----|-------|----------------|--|---|
| 501320 | 3221685013209 | | 10 | 200 | 22/65 | Vrac gencodé | | 1 |
| 501315 | 3221685013155 | | 10 | 200 | 22/65 | Vrac gencodé | | 1 |

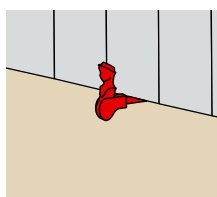
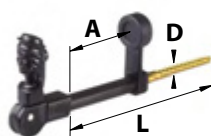

Arrêt tête bergère zamak à visser *

| Code | Gencod | | D | L | A | Type packaging | | |
|---------|---------------|--|----|-----|-------|-------------------|--|---|
| 0955206 | 3308189552066 | | 10 | 150 | 40/70 | Brochable gencodé | | 1 |
| 0954926 | 3308189549264 | | 10 | 150 | 40/70 | Brochable gencodé | | 1 |



La mise en œuvre des fermetures est encadrée par le DTU 34-4, s'y référer pour éviter tout danger.

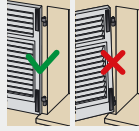

Bien s'assurer que le vantail soit monté plaqué et serré sur la façade.



En cas de vent, fermer les volets.



Pour les volets de grandes tailles, utiliser uniquement les arrêts adaptés



Conseils de pose P.133



Plus d'infos sur www.afbat.com

Arrêt composite automatique *

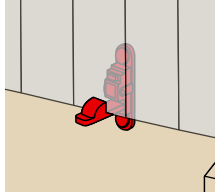

| Code | Gencod | | A | I | H | Type packaging | |
|---------|---------------|--|------|----|-----|----------------|----|
| 0108600 | 3308181086002 | | 6/36 | 32 | 110 | Vrac gencodé | 10 |
| 0108800 | 3308181088006 | | 6/86 | 32 | 110 | Vrac gencodé | 10 |
| 0108700 | 3308181087009 | | 6/36 | 32 | 110 | Vrac gencodé | 1 |
| 0108900 | 3308181089003 | | 6/86 | 32 | 110 | Vrac gencodé | 1 |
| 0260000 | 3308182600009 | | 6/36 | 32 | 110 | | 20 |
| 0942100 | 3308189421003 | | 6/86 | 32 | 110 | | 10 |

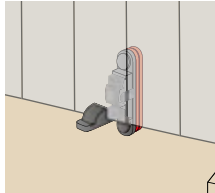

Cale arrêt composite automatique

| Code | Gencod | | I | H | Ep. | Type packaging | |
|---------|---------------|--|----|-----|-----|----------------|---|
| 0962200 | 3308189622004 | | 36 | 116 | 10 | Vrac gencodé | 5 |
| 0962100 | 3308189621007 | | 36 | 116 | 10 | Vrac gencodé | 5 |

Arrêt automatique aluminium *

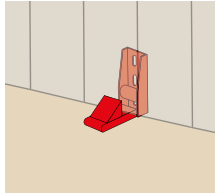

| Code | Gencod | | I | H | Type packaging | |
|---------------------------------|---------------|--|------|----|----------------|---|
| Pour volet de 40 à 58 mm | | | | | | |
| 4631002 | 3221684631022 | | 24,5 | 90 | Vrac gencodé | 1 |
| 4631001 | 3221684631008 | | 24,5 | 90 | Vrac gencodé | 1 |

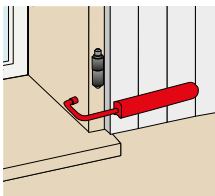
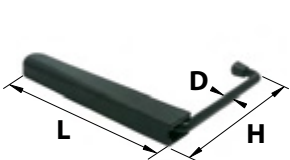

Arrêt de volet Veruilvolet (x2)

| Code | Gencod | | D | L | H | Type packaging | |
|---------|---------------|--|----|-----|-----|-------------------|---|
| 0952400 | 3308189524001 | | 12 | 250 | 135 | Brochable gencodé | 1 |
| 0958500 | 3308189585002 | | 12 | 250 | 135 | Brochable gencodé | 1 |



La mise en œuvre des fermetures est encadrée par le DTU 34-4, s'y référer pour éviter tout danger.



Surface maximum 1 m² par vantail.



Largeur maximum du volet : 500 mm.



Ne pas utiliser en zone venteuse.



En cas de vent, fermer les volets.



Utiliser tous les trous de fixation prévus à cet effet (5) pour fixer la pièce.



Vérifier le serrage régulièrement.



Conseils de pose P.133



Plus d'infos sur www.afbat.com



La mise en œuvre des fermetures est encadrée par le DTU 34-4, s'y référer pour éviter tout danger.

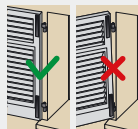

Bien s'assurer que le vantail soit monté plaqué et serré sur la façade.



En cas de vent, fermer les volets.



Pour les volets de grandes tailles, utiliser uniquement les arrêts adaptés



Conseils de pose P.133



Plus d'infos sur www.afbat.com

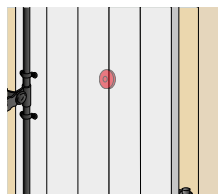
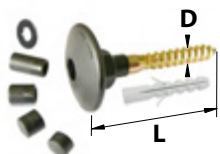

Butée murale composite à visser *

| Code | Gencod | | D | L | Type packaging | |
|---------|---------------|--|----|----|-------------------|---|
| 0956100 | 3308189561006 | | 10 | 75 | Brochable gencodé | 1 |

Crochets + crémaillères

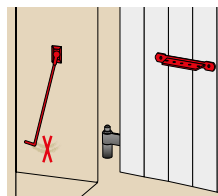
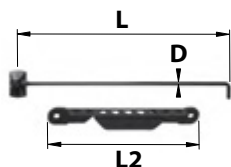

Crochet aluminium sur platine anti-choc + crémaillère à poignée

| Code | Gencod | | D | L | L2 | Type packaging | |
|---------|---------------|--|---|-----|-----|-------------------|---|
| 0956801 | 3308189568012 | | 8 | 480 | 180 | Brochable gencodé | 1 |

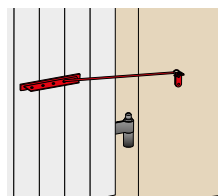
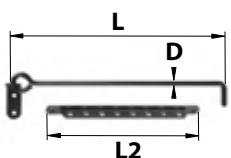

Crochet aluminium sur platine + crémaillère en T

| Code | Gencod | | D | L | L2 | Type packaging | |
|---------|---------------|--|---|-----|-----|----------------|---|
| 0963201 | 3308189632010 | | 8 | 300 | 180 | Vrac gencodé | 5 |
| 0963226 | 3308189632263 | | 8 | 300 | 180 | Vrac gencodé | 5 |

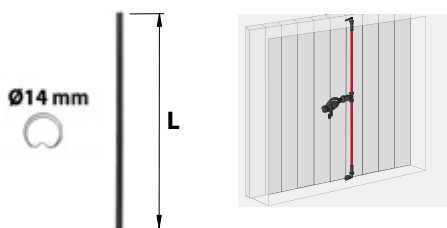

Tube espagnolette rainurée aluminium

| Code | Gencod | | D | L | Type packaging | |
|--------|---------------|--|----|------|----------------|---|
| 620500 | 3221686205009 | | 14 | 1270 | Vrac gencodé | 1 |
| 620502 | 3221686205023 | | 14 | 1570 | Vrac gencodé | 1 |
| 465627 | 3221684656278 | | 14 | 1270 | Vrac gencodé | 1 |
| 465626 | 3221684656261 | | 14 | 1570 | Vrac gencodé | 1 |



Accessoires espagnolette zamak rainurée

| Code | Gencod | | Type packaging | |
|---------|---------------|--|-------------------|---|
| 0959800 | 3308189598002 | | Brochable gencodé | 1 |

Composition

- 1 poignée sécurité intégrée
- 1 support
- 4 lacets
- 2 crochets

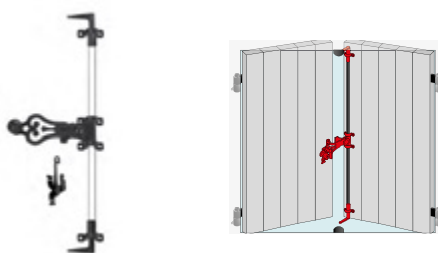

Accessoires espagnolette aluminium rainurée

| Code | Gencod | | Type packaging | |
|---------|---------------|--|-------------------|---|
| 0954200 | 3308189542005 | | Brochable gencodé | 1 |
| 0954100 | 3308189541008 | | Brochable gencodé | 1 |

Composition

- 1 poignée
- 1 support antisoulèvement
- 4 lacets
- 2 crochets

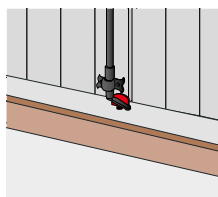

Butée à vis + tampon composite

| Code | Gencod | | D | L | I | Type packaging | |
|---------|---------------|--|-----|----|----|-------------------|---|
| 0961800 | 3308189618007 | | 6,5 | 65 | 39 | Brochable gencodé | 1 |
| 0961700 | 3308189617000 | | 6,5 | 65 | 39 | Brochable gencodé | 1 |

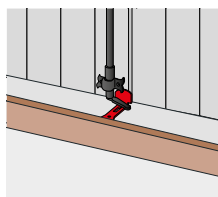
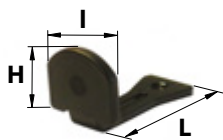

Butée coudée réglable à visser + tampon composite

| Code | Gencod | | L | I | H | Type packaging | |
|---------|---------------|--|----|----|----|-------------------|----|
| 0962000 | 3308189620000 | | 66 | 39 | 40 | Brochable gencodé | 1 |
| 0961900 | 3308189619004 | | 66 | 39 | 40 | Brochable gencodé | 1 |
| 0941700 | 3308189417006 | | 66 | 39 | 40 | | 25 |



L'EXTÉRIEUR DE L'HABITAT

L'ISOLATION EXTÉRIEURE

A chaque produit son cas de figure

Afin de répondre de la meilleure façon à tous les types de pose, AFBAT® propose un large éventail de produits adaptés à des contraintes spécifiques.

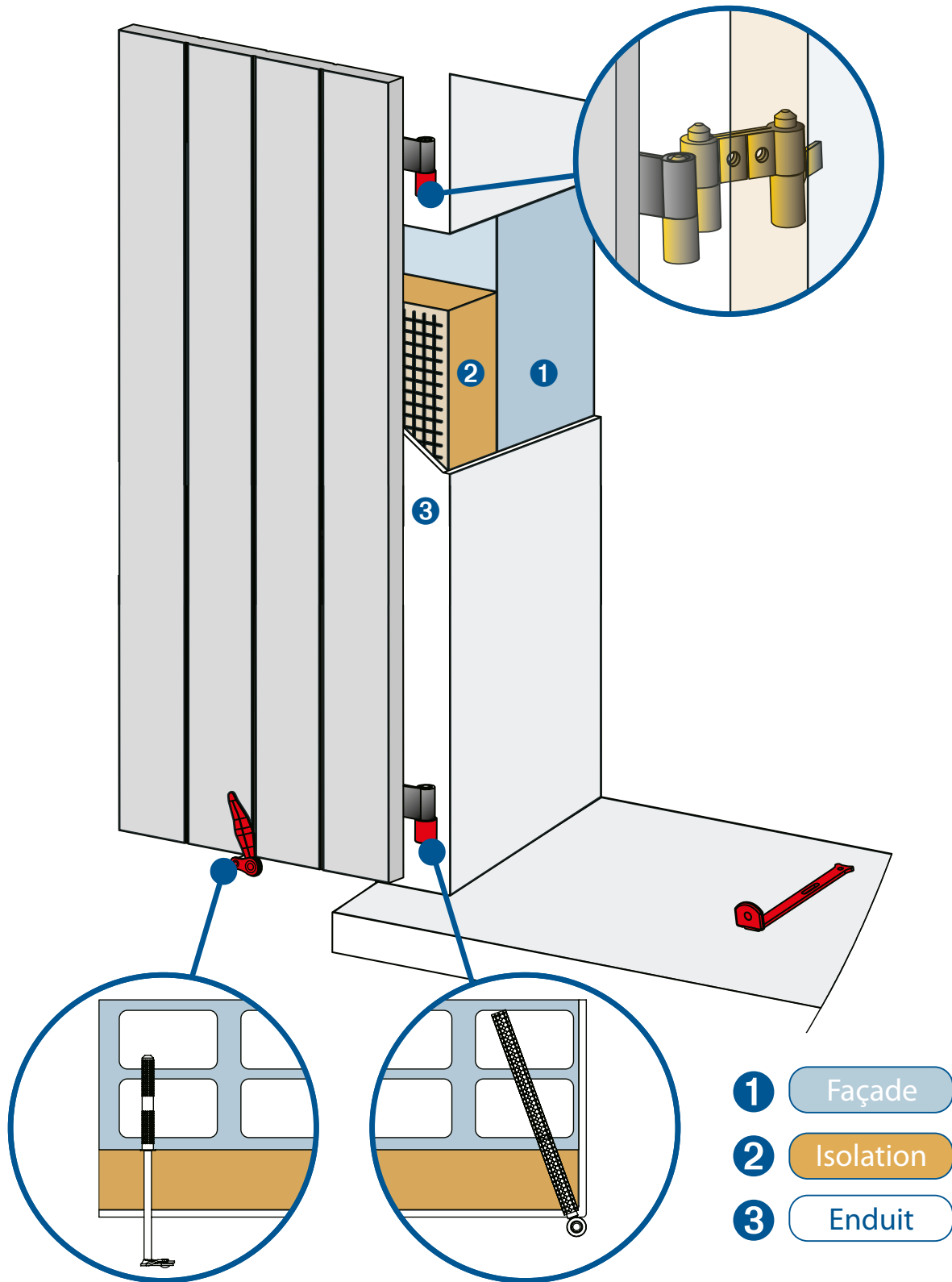

Gond à scellement chimique composite (kit)

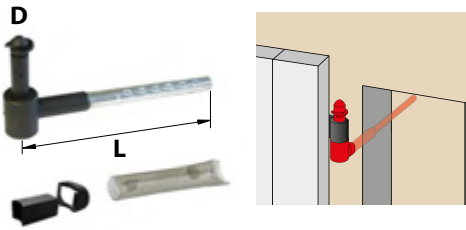

| Code | Gencod | | D | L | Type packaging | |
|---------|---------------|--|----|-----|----------------|---|
| 0419401 | 3308184194018 | | 14 | 180 | Vrac gencodé | 1 |
| 0432501 | 3308184325016 | | 14 | 300 | Vrac gencodé | 1 |

Composition
 1 gond
 1 entretoise
 1 bague de propreté
 1 tamis métallique

Gond à scellement chimique acier (kit)

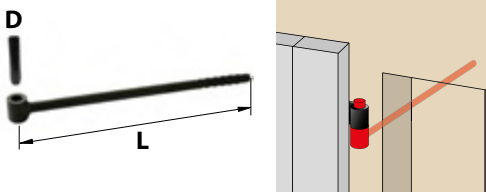

| Code | Gencod | | D | D2 | L | Type packaging | |
|------------|---------------|--|----|----|-----|----------------|----|
| 0443501 | 3308184435012 | | 14 | 14 | 180 | Vrac gencodé | 1 |
| 0467801 | 3308184678013 | | 14 | 14 | 300 | Vrac gencodé | 1 |
| 61ISOXT35M | 3517650578676 | | 14 | 20 | 350 | Vrac gencodé | 10 |

Composition
 1 gond
 1 tamis métallique
 1 élastique

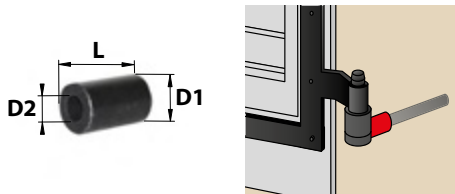

Entretoise pour gond acier (x2)

| Code | Gencod | | L | D1 | D2 | Type packaging | |
|---------|---------------|--|------|----|----|-------------------|---|
| 0952701 | 3308189527019 | | 43,2 | 20 | 11 | Brochable gencodé | 1 |

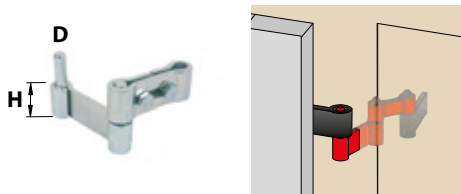

Gond pour isolation extérieure Isogond

| Code | Gencod | | D | H | Ep. | Type packaging | |
|---------|---------------|---------|----|----|-----|----------------|---|
| 0417303 | 3308184173037 | Z.BLANC | 14 | 30 | 5 | Vrac gencodé | 1 |
| 0417403 | 3308184174034 | Z.BLANC | 16 | 30 | 5 | Vrac gencodé | 1 |

Arrêts de volets à visser



La mise en œuvre des fermetures est encadrée par le DTU 34-4, s'y référer pour éviter tout danger.

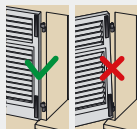

Bien s'assurer que le vantail soit monté plaqué et serré sur la façade.



En cas de vent, fermer les volets.



Pour les volets de grandes tailles, utiliser uniquement les arrêts adaptés.



Conseils de pose P.138



Plus d'infos sur www.afbat.com

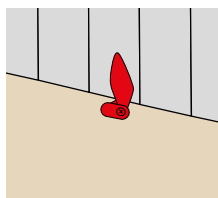
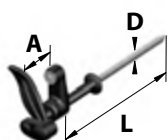

Tourniquet marseillais composite à visser *

| Code | Gencod | | D | L | A | Type packaging | |
|---------|---------------|--|----|-----|--------|----------------|---|
| 0418501 | 3308184185016 | | 10 | 280 | 12/116 | Vrac gencodé | 1 |
| 0418702 | 3308184187027 | | 10 | 280 | 12/116 | Vrac gencodé | 1 |

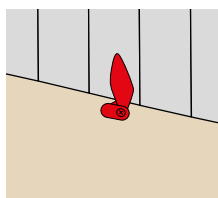

Tourniquet marseillais acier à visser *

| Code | Gencod | | D | L | Type packaging | |
|---------|---------------|--|----|-----|----------------|----|
| 0426701 | 3308184267019 | | 10 | 180 | | 20 |
| 0417501 | 3308184175017 | | 10 | 250 | Vrac gencodé | 1 |

Arrêts tête bergère à visser

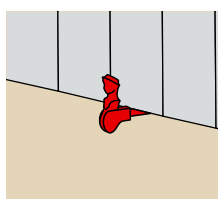
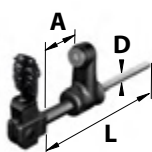

Arret tête bergère composite à visser *

| Code | Gencod | | D | L | A | Type packaging | |
|---------|---------------|--|----|-----|--------|----------------|---|
| 0418801 | 3308184188017 | | 10 | 280 | 22/115 | Vrac gencodé | 1 |

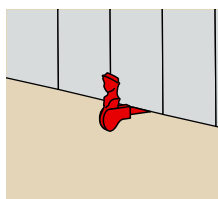

Arret tête bergère acier à visser *

| Code | Gencod | | D | L | Type packaging | |
|---------|---------------|--|----|-----|----------------|---|
| 0787501 | 3308187875013 | | 10 | 250 | Vrac gencodé | 5 |



L'EXTÉRIEUR DE L'HABITAT

LA SÉCURITÉ DU VOLET

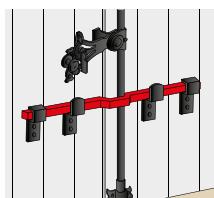
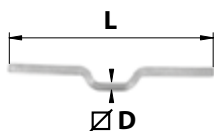

Barre de sécurité renforcée

| Code | Gencod | | ∅ D | L | Type packaging | |
|---------|---------------|---------|-----|------|----------------|---|
| 0640903 | 3308186409035 | Z.BLANC | 16 | 410 | Vrac gencodé | 1 |
| 0705903 | 3308187059031 | Z.BLANC | 16 | 980 | Vrac gencodé | 1 |
| 0706003 | 3308187060037 | Z.BLANC | 16 | 1480 | Vrac gencodé | 1 |

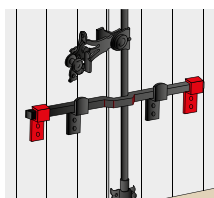

Support antisoulèvement barre de sécurité pour carré 16

| Code | Gencod | | L | H | Ep. | Type packaging | |
|-------------|---------------|---------|----|------|-----|-------------------|-----|
| (x1) | | | | | | | |
| 0802103 | 3308180030778 | Z.BLANC | 25 | 69,5 | 3,5 | Vrac gencodé | 10 |
| 0247403 | 3308182474037 | Z.BLANC | 25 | 69,5 | 3,5 | | 100 |
| (x2) | | | | | | | |
| 0711603 | 3308187116031 | Z.BLANC | 25 | 69,5 | 3,5 | Brochable gencodé | 1 |

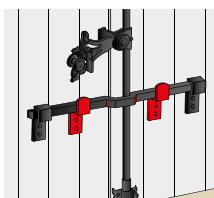
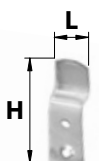

Support simple barre de sécurité pour carré 16

| Code | Gencod | | L | H | Ep. | Type packaging | |
|-------------|---------------|---------|----|----|-----|----------------|-----|
| (x1) | | | | | | | |
| 0801903 | 3308180030761 | Z.BLANC | 25 | 75 | 3,5 | Vrac gencodé | 10 |
| 0247503 | 3308182475034 | Z.BLANC | 25 | 75 | 3,5 | | 100 |

Support simple (x2) + contre-plaque (x2)

| | | | | | | | |
|---------|---------------|---------|----|----|-----|-------------------|---|
| 0711504 | 3308187115041 | | 25 | 75 | 3,5 | Brochable gencodé | 1 |
| 0711503 | 3308187115034 | Z.BLANC | 25 | 75 | 3,5 | Brochable gencodé | 1 |

Support simple barre (x4) + Visserie

| | | | | | | | |
|---------|---------------|---------|----|----|-----|-------------------|---|
| 0409203 | 3308184092031 | Z.BLANC | 25 | 75 | 3,5 | Brochable gencodé | 1 |
|---------|---------------|---------|----|----|-----|-------------------|---|

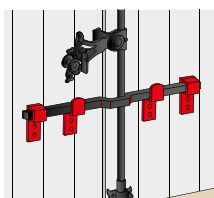

Kit support barre de sécurité pour carré 16

| Code | Gencod | | Type packaging | |
|--|---------------|---------|-------------------|---|
| Support simple (x2) + antisoulèvement (x2) + Visserie | | | | |
| 0318104 | 3308183181040 | | Vrac gencodé | 1 |
| 0318103 | 3308183181033 | Z.BLANC | Vrac gencodé | 1 |
| Support simple (x2) + antisoulèvement (x2) + contre-plaques (x4) + Visserie | | | | |
| 0409103 | 3308184091034 | Z.BLANC | Brochable gencodé | 1 |

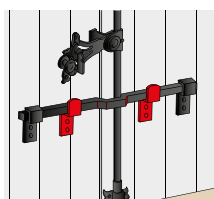
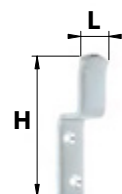

Support ouvert barre de sécurité

| Code | Gencod | | L | H | Type packaging | |
|---------------------------------|---------------|---------|----|----|----------------|----|
| Pour carré de 25 mm | | | | | | |
| 6139025 | 3221686139250 | Z.BLANC | 20 | 94 | Vrac gencodé | 10 |
| Pour carré de 25 à 36 mm | | | | | | |
| 6139036 | 3221686139366 | Z.BLANC | 20 | 94 | Vrac gencodé | 10 |

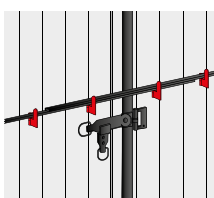

Support charnière pour barre de sécurité 12 mm

| Code | Gencod | | L1 | L2 | H | Ep. | Type packaging | |
|---------------------------------|---------------|---------|----|------|----|-----|----------------|----|
| A visser - Modèle droite | | | | | | | | |
| 538130 | 3479045381301 | Z.BLANC | 34 | 23,5 | 67 | 2 | Vrac gencodé | 10 |
| A visser - Modèle gauche | | | | | | | | |
| 538140 | 3479045381400 | Z.BLANC | 34 | 23,5 | 67 | 2 | Vrac gencodé | 10 |

Modèle droite

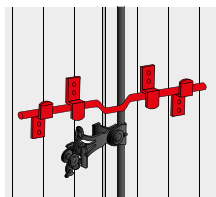
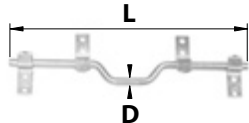

Barre de sécurité ronde

| Code | Gencod | | ∅ D | L | Type packaging | |
|---------|---------------|---------|-----|-----|-------------------|---|
| 0337103 | 3308183371038 | Z.BLANC | 14 | 410 | Brochable gencodé | 1 |

Composition
 1 barre de sécurité L41 cm
 4 supports droits
 Visserie

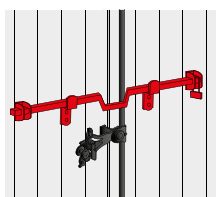
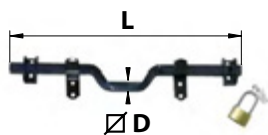

Barre de sécurité renforcée + cadenas

| Code | Gencod | | ∅ D | L | Type packaging | |
|---------|---------------|--|-----|-----|-------------------|---|
| 0337504 | 3308183375043 | | 16 | 410 | Brochable gencodé | 1 |

Composition
 1 barre de sécurité L41 cm percée pour passage du cadenas
 2 supports droits + 2 supports sécurité
 1 cadenas
 Visserie

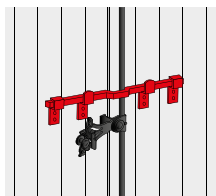
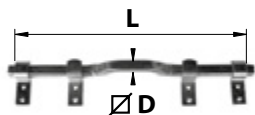

Barre de sécurité renforcée

| Code | Gencod | | ∅ D | L | Type packaging | |
|---------|---------------|---------|-----|-----|-------------------|---|
| 0707004 | 3308180029949 | | 16 | 410 | Brochable gencodé | 1 |
| 0802204 | 3308188022041 | | 16 | 980 | Brochable gencodé | 1 |
| 0707003 | 3308187070036 | Z.BLANC | 16 | 410 | Brochable gencodé | 1 |
| 0802203 | 3308180029796 | Z.BLANC | 16 | 980 | Brochable gencodé | 1 |

Composition
 1 barre de sécurité
 2 supports simples
 2 supports anti-soulèvements
 4 contre-plaques (uniquement pour L98 cm)
 Visserie

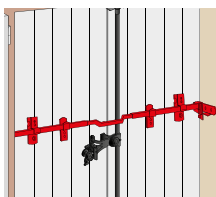
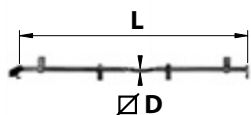

Barre de sécurité réglable 6 points

| Code | Gencod | | ∅ D | L | Type packaging | |
|---------|---------------|--|-----|-----|-------------------|---|
| 0704404 | 3308187044044 | | 16 | 410 | Brochable gencodé | 1 |

Composition
 1 barre de sécurité L41 cm
 2 rallonges
 2 supports intermédiaires
 2 supports verrous
 2 supports tableau

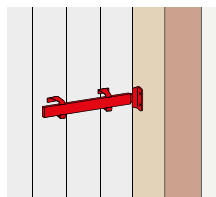
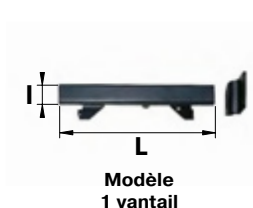

Barre de sécurité verrou

| Code | Gencod | | L | I | Type packaging | |
|------------------|---------------|--|-----------|----|-------------------|---|
| 1 vantail | | | | | | |
| 0337706 | 3308183377061 | | 245 | 30 | Brochable gencodé | 1 |
| 2 vantaux | | | | | | |
| 0777406 | 3308180029802 | | 245 + 245 | 30 | Brochable gencodé | 1 |

Composition

Pour 1 vantail :

- 1 fourreau avec pêne cadennassable
- 1 gâche murale à visser
- Visserie

Pour 2 vantaux :

- 1 fourreau avec pêne cadennassable
- 1 fourreau sans pêne
- Visserie

Barre de sécurité à boutons

| Code | Gencod | | L | Type packaging | |
|---------|---------------|--|-----|-------------------|---|
| 0318304 | 3308183183044 | | 450 | Brochable gencodé | 1 |

Composition

- 1 barre de sécurité L450 mm
- 2 supports simples
- 2 supports antisoulèvement
- Visserie

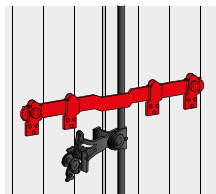
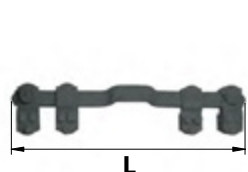

Barre de sécurité plate à ergots

| Code | Gencod | | L | Type packaging | |
|------------------|---------------|---------|-----|-------------------|---|
| Acier | | | | | |
| 0174403 | 3308181744032 | Z.BLANC | 450 | Brochable gencodé | 1 |
| Aluminium | | | | | |
| 0312906 | 3308183129066 | | 450 | Brochable gencodé | 1 |
| 0312926 | 3308183129264 | | 450 | Brochable gencodé | 1 |

Composition

- 1 barre de sécurité L450 mm
- 2 supports simples
- 2 supports antisoulèvement
- Visserie

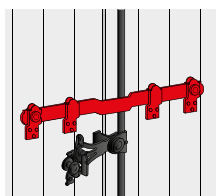
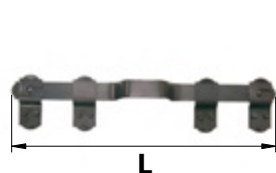

Entrebâilleur de volet

| Code | Gencod | | L | I | Type packaging | |
|---------|---------------|---------|-----|----|-------------------|---|
| 0700104 | 3308180040555 | | 285 | 83 | Brochable gencodé | 1 |
| 0700103 | 3308187001030 | Z.BLANC | 285 | 83 | Brochable gencodé | 1 |
| 0942703 | 3308189427036 | Z.BLANC | 285 | 83 | | 5 |

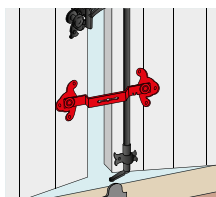
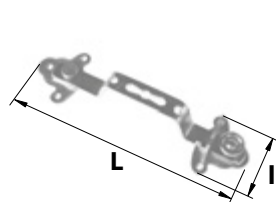



L'EXTÉRIEUR DE L'HABITAT

LES PERSIENNES

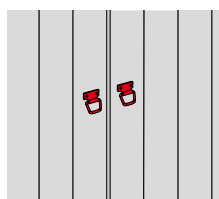
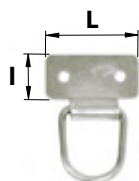

Anneau de tirage (x2)

| Code | Gencod | | L | I | Type packaging | |
|---------|---------------|---------|----|----|-------------------|---|
| 0952303 | 3308189523035 | Z.BLANC | 40 | 20 | Brochable gencodé | 1 |

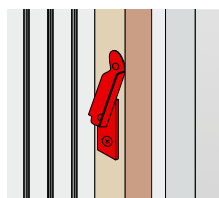

Modèle gauche

Arrêt de persienne à visser

| Code | Gencod | | L | I | H | Ep. | Type packaging | |
|-------------------------------|---------------|---------|----|----|----|-----|-------------------|----|
| Modèle droite | | | | | | | | |
| 0382703 | 3308183827030 | Z.BLANC | 90 | 20 | 60 | 3 | Vrac gencodé | 10 |
| Modèle gauche | | | | | | | | |
| 0382603 | 3308183826033 | Z.BLANC | 90 | 20 | 60 | 3 | Vrac gencodé | 10 |
| Modèle droite + gauche | | | | | | | | |
| 0701503 | 3308187015037 | Z.BLANC | 90 | 20 | 60 | 3 | Brochable gencodé | 1 |

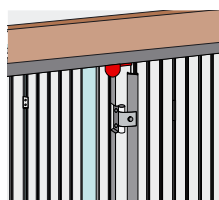

Butée de persienne à visser

| Code | Gencod | | L | I | H | Ep. | Type packaging | |
|--------------------|---------------|---------|----|------|----|-----|-------------------|----|
| Modèle haut | | | | | | | | |
| 538071 | 3221685380714 | | 30 | 23 | 27 | 2,5 | Vrac gencodé | 10 |
| 538070 | 3479045380700 | Z.BLANC | 30 | 23 | 27 | 2,5 | Vrac gencodé | 10 |
| 0961603 | 3308189616034 | Z.BLANC | 30 | 20 | 31 | 2,5 | Brochable gencodé | 1 |
| Modèle bas | | | | | | | | |
| 538081 | 3479045380816 | | 30 | 30 | 30 | 2,5 | Vrac gencodé | 10 |
| 538080 | 3479045380809 | Z.BLANC | 30 | 30 | 30 | 2,5 | Vrac gencodé | 10 |
| 538090 | 3479045380908 | Z.BLANC | 30 | 23 | 36 | 2,5 | Vrac gencodé | 10 |
| 0961503 | 3308189615037 | Z.BLANC | 30 | 30,5 | 30 | 2,5 | Brochable gencodé | 1 |

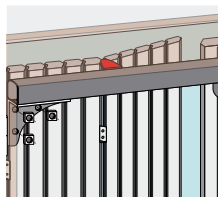
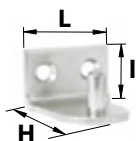

Crochet de rappel

| Code | Gencod | | L | I | H | Ep. | Type packaging | |
|---------|---------------|---------|----|----|----|-----|-------------------|---|
| 0962803 | 3308189628037 | Z.BLANC | 30 | 20 | 31 | 2,5 | Brochable gencodé | 1 |

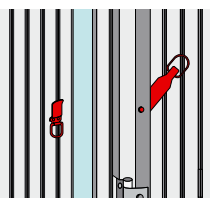
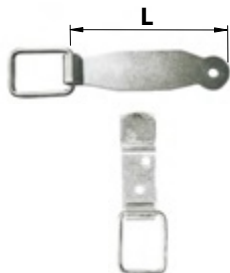

Loquet droit + support

| Code | Gencod | | L | Ep. | Type packaging | |
|---------|---------------|---------|----|-----|-------------------|---|
| 0957303 | 3308189573030 | Z.BLANC | 98 | 2,5 | Brochable gencodé | 1 |

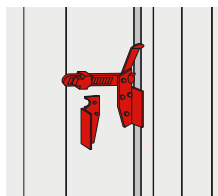

Loquet de persienne + support

| Code | Gencod | | L | Ep. | Type packaging | |
|---------|---------------|------|-----|-----|-------------------|---|
| 0963916 | 3308189639163 | GRIS | 201 | 2,5 | Brochable gencodé | 1 |

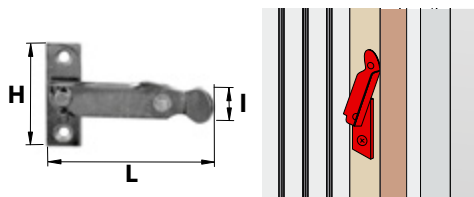

Modèle droite

Arrêt de persienne inox à visser + butée

| Code | Gencod | | L | I | H | Ep. | Type packaging | |
|----------------------|---------------|------|-------|----|----|-----|----------------|---|
| Modèle droite | | | | | | | | |
| 0960500 | 3308189605007 | 304L | 113,5 | 21 | 62 | 2 | Vrac gencodé | 1 |
| Modèle gauche | | | | | | | | |
| 0960600 | 3308189606004 | 304L | 113,5 | 21 | 62 | 2 | Vrac gencodé | 1 |

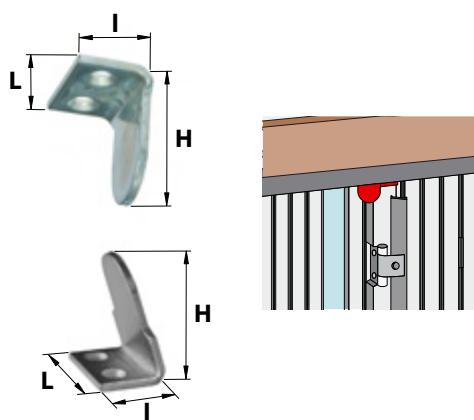

Butée de persienne inox à visser

| Code | Gencod | | L | I | H | Ep. | Type packaging | |
|--------------------|---------------|------|----|----|------|-----|-------------------|---|
| Modèle haut | | | | | | | | |
| 0962703 | 3308189627030 | 304L | 30 | 20 | 30,5 | 2 | Brochable gencodé | 1 |
| Modèle bas | | | | | | | | |
| 0961403 | 3308189614030 | 304L | 30 | 20 | 40 | 2 | Brochable gencodé | 1 |

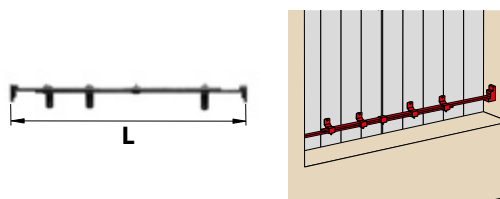

Barre de sécurité persienne recoupable

| Code | Gencod | | L | Type packaging | |
|---------|---------------|---------|------|-------------------|---|
| 0704203 | 3308187042033 | Z.BLANC | 1600 | Brochable gencodé | 1 |



L'EXTÉRIEUR DE L'HABITAT

L'ISOLATION EXTÉRIEURE

A chaque produit son cas de figure

Afin de répondre de la meilleure façon à tous les types de pose, AFBAT® propose un large éventail de produits adaptés à des contraintes spécifiques.

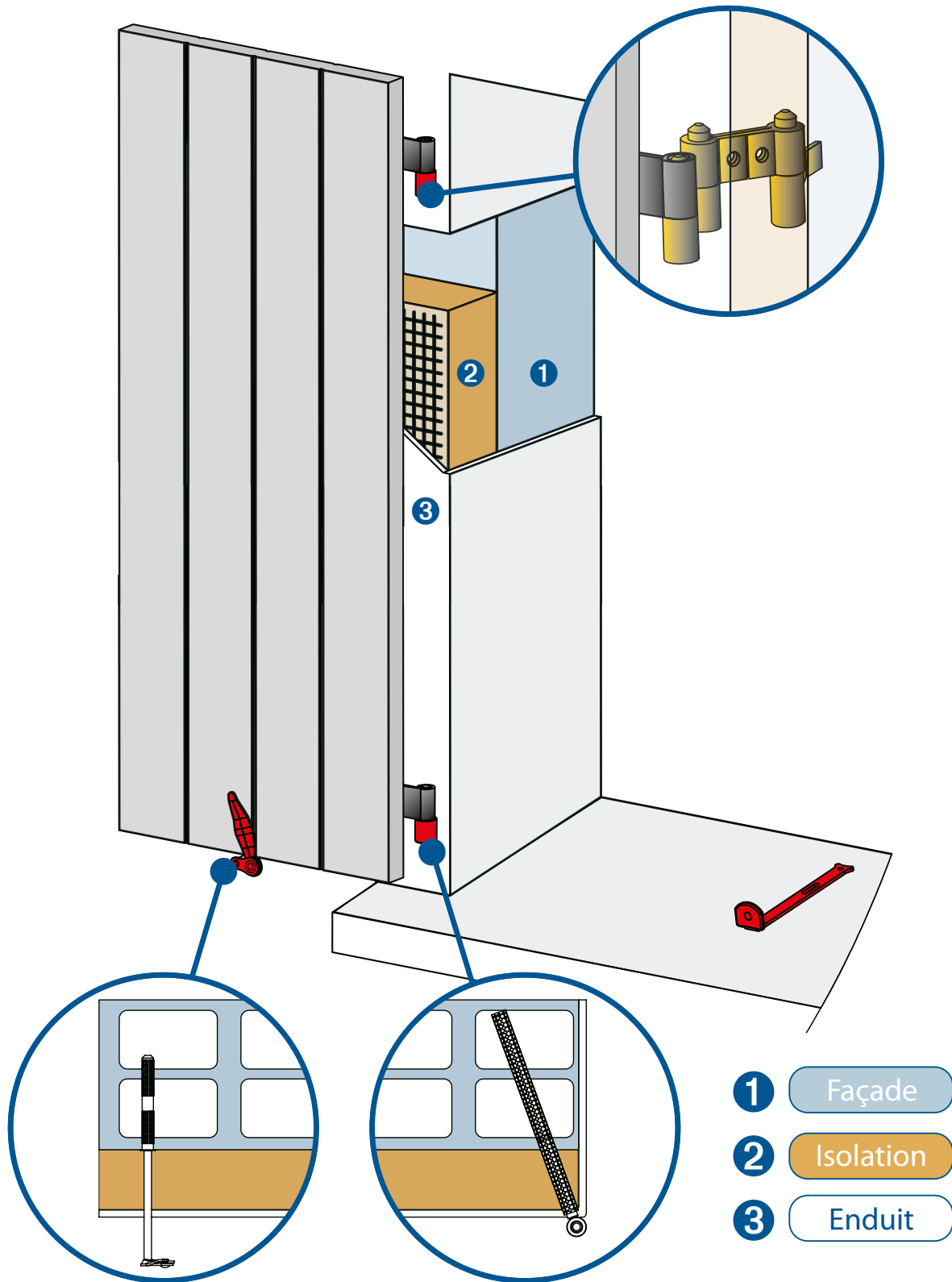

Gond à scellement chimique composite (kit)

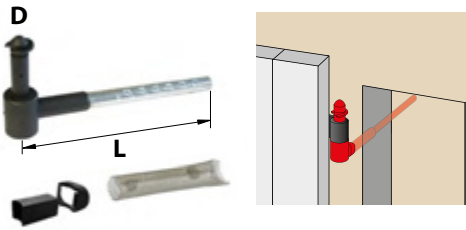

| Code | Gencod | | D | L | Type packaging | |
|---------|---------------|--|----|-----|----------------|---|
| 0419401 | 3308184194018 | | 14 | 180 | Vrac gencodé | 1 |
| 0432501 | 3308184325016 | | 14 | 300 | Vrac gencodé | 1 |

Composition
 1 gond
 1 entretoise
 1 bague de propreté
 1 tamis métallique

Gond à scellement chimique acier (kit)

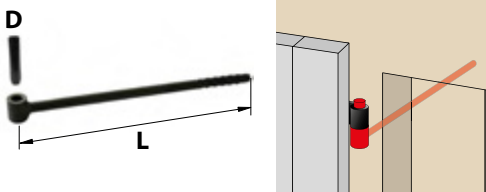

| Code | Gencod | | D | D2 | L | Type packaging | |
|------------|---------------|--|----|----|-----|----------------|----|
| 0443501 | 3308184435012 | | 14 | 14 | 180 | Vrac gencodé | 1 |
| 0467801 | 3308184678013 | | 14 | 14 | 300 | Vrac gencodé | 1 |
| 61ISOXT35M | 3517650578676 | | 14 | 20 | 350 | Vrac gencodé | 10 |

Composition
 1 gond
 1 tamis métallique
 1 élastique

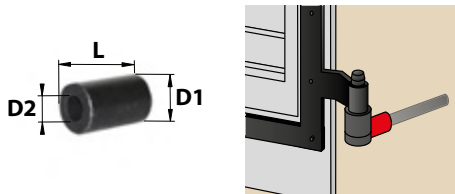

Entretoise pour gond acier (x2)

| Code | Gencod | | L | D1 | D2 | Type packaging | |
|---------|---------------|--|------|----|----|-------------------|---|
| 0952701 | 3308189527019 | | 43,2 | 20 | 11 | Brochable gencodé | 1 |

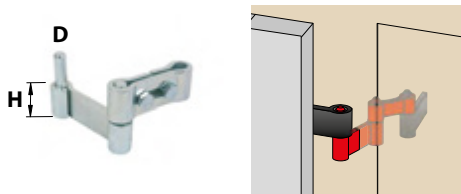

Gond pour isolation extérieure Isogond

| Code | Gencod | | D | H | Ep. | Type packaging | |
|---------|---------------|---------|----|----|-----|----------------|---|
| 0417303 | 3308184173037 | Z.BLANC | 14 | 30 | 5 | Vrac gencodé | 1 |
| 0417403 | 3308184174034 | Z.BLANC | 16 | 30 | 5 | Vrac gencodé | 1 |

Arrêts de volets à visser



La mise en œuvre des fermetures est encadrée par le DTU 34-4, s'y référer pour éviter tout danger.

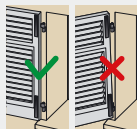

Bien s'assurer que le vantail soit monté plaqué et serré sur la façade.



En cas de vent, fermer les volets.



Pour les volets de grandes tailles, utiliser uniquement les arrêts adaptés.



Conseils de pose P.138



Plus d'infos sur www.afbat.com

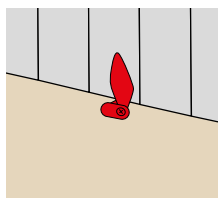
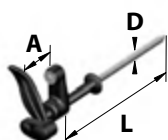

Tourniquet marseillais composite à visser *

| Code | Gencod | | D | L | A | Type packaging | |
|---------|---------------|--|----|-----|--------|----------------|---|
| 0418501 | 3308184185016 | | 10 | 280 | 12/116 | Vrac gencodé | 1 |
| 0418702 | 3308184187027 | | 10 | 280 | 12/116 | Vrac gencodé | 1 |

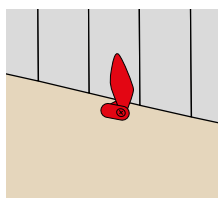

Tourniquet marseillais acier à visser *

| Code | Gencod | | D | L | Type packaging | |
|---------|---------------|--|----|-----|----------------|----|
| 0426701 | 3308184267019 | | 10 | 180 | | 20 |
| 0417501 | 3308184175017 | | 10 | 250 | Vrac gencodé | 1 |

Arrêts tête bergère à visser

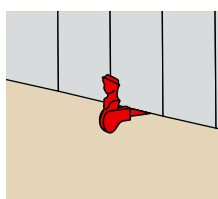
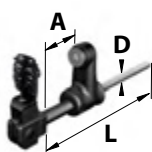

Arret tête bergère composite à visser *

| Code | Gencod | | D | L | A | Type packaging | |
|---------|---------------|--|----|-----|--------|----------------|---|
| 0418801 | 3308184188017 | | 10 | 280 | 22/115 | Vrac gencodé | 1 |

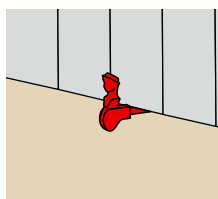

Arret tête bergère acier à visser *

| Code | Gencod | | D | L | Type packaging | |
|---------|---------------|--|----|-----|----------------|---|
| 0787501 | 3308187875013 | | 10 | 250 | Vrac gencodé | 5 |



L'EXTÉRIEUR DE L'HABITAT

LA SÉCURITÉ DU VOLET

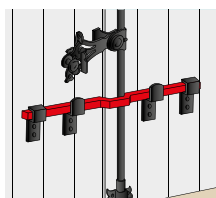
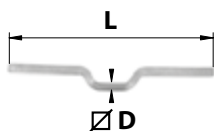

Barre de sécurité renforcée

| Code | Gencod | | ∅ D | L | Type packaging | |
|---------|---------------|---------|-----|------|----------------|---|
| 0640903 | 3308186409035 | Z.BLANC | 16 | 410 | Vrac gencodé | 1 |
| 0705903 | 3308187059031 | Z.BLANC | 16 | 980 | Vrac gencodé | 1 |
| 0706003 | 3308187060037 | Z.BLANC | 16 | 1480 | Vrac gencodé | 1 |

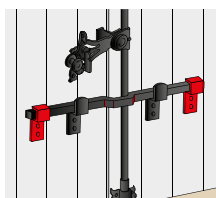

Support antisoulèvement barre de sécurité pour carré 16

| Code | Gencod | | L | H | Ep. | Type packaging | |
|-------------|---------------|---------|----|------|-----|-------------------|-----|
| (x1) | | | | | | | |
| 0802103 | 3308180030778 | Z.BLANC | 25 | 69,5 | 3,5 | Vrac gencodé | 10 |
| 0247403 | 3308182474037 | Z.BLANC | 25 | 69,5 | 3,5 | | 100 |
| (x2) | | | | | | | |
| 0711603 | 3308187116031 | Z.BLANC | 25 | 69,5 | 3,5 | Brochable gencodé | 1 |

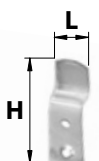

Support simple barre de sécurité pour carré 16

| Code | Gencod | | L | H | Ep. | Type packaging | |
|-------------|---------------|---------|----|----|-----|----------------|-----|
| (x1) | | | | | | | |
| 0801903 | 3308180030761 | Z.BLANC | 25 | 75 | 3,5 | Vrac gencodé | 10 |
| 0247503 | 3308182475034 | Z.BLANC | 25 | 75 | 3,5 | | 100 |

Support simple (x2) + contre-plaque (x2)

| | | | | | | | |
|---------|---------------|---------|----|----|-----|-------------------|---|
| 0711504 | 3308187115041 | | 25 | 75 | 3,5 | Brochable gencodé | 1 |
| 0711503 | 3308187115034 | Z.BLANC | 25 | 75 | 3,5 | Brochable gencodé | 1 |

Support simple barre (x4) + Visserie

| | | | | | | | |
|---------|---------------|---------|----|----|-----|-------------------|---|
| 0409203 | 3308184092031 | Z.BLANC | 25 | 75 | 3,5 | Brochable gencodé | 1 |
|---------|---------------|---------|----|----|-----|-------------------|---|

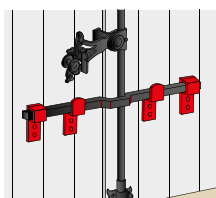

Kit support barre de sécurité pour carré 16

| Code | Gencod | | Type packaging | |
|--|---------------|---------|-------------------|---|
| Support simple (x2) + antisoulèvement (x2) + Visserie | | | | |
| 0318104 | 3308183181040 | | Vrac gencodé | 1 |
| 0318103 | 3308183181033 | Z.BLANC | Vrac gencodé | 1 |
| Support simple (x2) + antisoulèvement (x2) + contre-plaques (x4) + Visserie | | | | |
| 0409103 | 3308184091034 | Z.BLANC | Brochable gencodé | 1 |

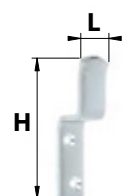

Support ouvert barre de sécurité

| Code | Gencod | | L | H | Type packaging | |
|---------------------------------|---------------|---------|----|----|----------------|----|
| Pour carré de 25 mm | | | | | | |
| 6139025 | 3221686139250 | Z.BLANC | 20 | 94 | Vrac gencodé | 10 |
| Pour carré de 25 à 36 mm | | | | | | |
| 6139036 | 3221686139366 | Z.BLANC | 20 | 94 | Vrac gencodé | 10 |

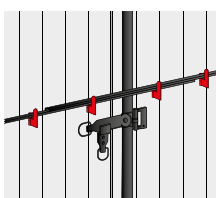

Support charnière pour barre de sécurité 12 mm

| Code | Gencod | | L1 | L2 | H | Ep. | Type packaging | |
|---------------------------------|---------------|---------|----|------|----|-----|----------------|----|
| A visser - Modèle droite | | | | | | | | |
| 538130 | 3479045381301 | Z.BLANC | 34 | 23,5 | 67 | 2 | Vrac gencodé | 10 |
| A visser - Modèle gauche | | | | | | | | |
| 538140 | 3479045381400 | Z.BLANC | 34 | 23,5 | 67 | 2 | Vrac gencodé | 10 |

Modèle droite

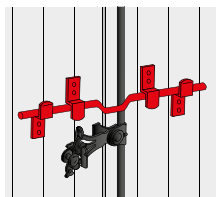
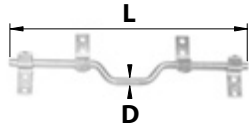

Barre de sécurité ronde

| Code | Gencod | | ∅ D | L | Type packaging | |
|---------|---------------|---------|-----|-----|-------------------|---|
| 0337103 | 3308183371038 | Z.BLANC | 14 | 410 | Brochable gencodé | 1 |

Composition
 1 barre de sécurité L41 cm
 4 supports droits
 Visserie

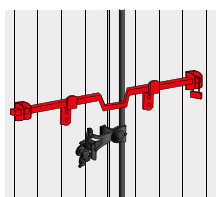
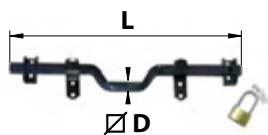

Barre de sécurité renforcée + cadenas

| Code | Gencod | | ∅ D | L | Type packaging | |
|---------|---------------|--|-----|-----|-------------------|---|
| 0337504 | 3308183375043 | | 16 | 410 | Brochable gencodé | 1 |

Composition
 1 barre de sécurité L41 cm percée pour passage du cadenas
 2 supports droits + 2 supports sécurité
 1 cadenas
 Visserie

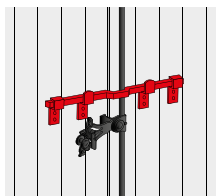
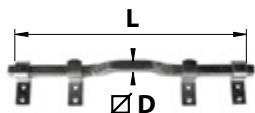

Barre de sécurité renforcée

| Code | Gencod | | ∅ D | L | Type packaging | |
|---------|---------------|---------|-----|-----|-------------------|---|
| 0707004 | 3308180029949 | | 16 | 410 | Brochable gencodé | 1 |
| 0802204 | 3308188022041 | | 16 | 980 | Brochable gencodé | 1 |
| 0707003 | 3308187070036 | Z.BLANC | 16 | 410 | Brochable gencodé | 1 |
| 0802203 | 3308180029796 | Z.BLANC | 16 | 980 | Brochable gencodé | 1 |

Composition
 1 barre de sécurité
 2 supports simples
 2 supports anti-soulèvements
 4 contre-plaques (uniquement pour L98 cm)
 Visserie

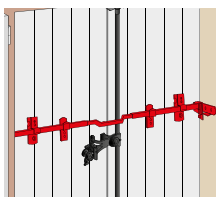
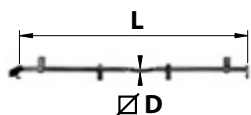

Barre de sécurité réglable 6 points

| Code | Gencod | | ∅ D | L | Type packaging | |
|---------|---------------|--|-----|-----|-------------------|---|
| 0704404 | 3308187044044 | | 16 | 410 | Brochable gencodé | 1 |

Composition
 1 barre de sécurité L41 cm
 2 rallonges
 2 supports intermédiaires
 2 supports verrous
 2 supports tableau

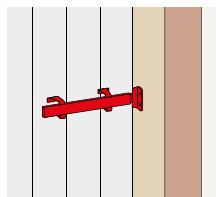
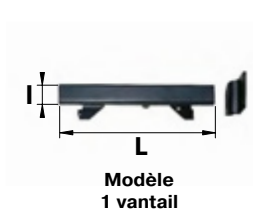

Barre de sécurité verrou

| Code | Gencod | | L | I | Type packaging | |
|------------------|---------------|--|-----------|----|-------------------|---|
| 1 vantail | | | | | | |
| 0337706 | 3308183377061 | | 245 | 30 | Brochable gencodé | 1 |
| 2 vantaux | | | | | | |
| 0777406 | 3308180029802 | | 245 + 245 | 30 | Brochable gencodé | 1 |

Composition

Pour 1 vantail :

- 1 fourreau avec pêne cadenassable
- 1 gâche murale à visser
- Visserie

Pour 2 vantaux :

- 1 fourreau avec pêne cadenassable
- 1 fourreau sans pêne
- Visserie

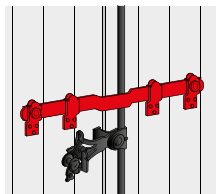

Barre de sécurité à boutons

| Code | Gencod | | L | Type packaging | |
|---------|---------------|--|-----|-------------------|---|
| 0318304 | 3308183183044 | | 450 | Brochable gencodé | 1 |

Composition

- 1 barre de sécurité L450 mm
- 2 supports simples
- 2 supports antisoulèvement
- Visserie

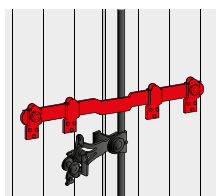
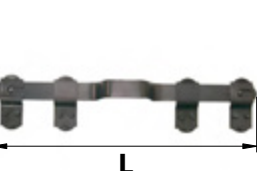

Barre de sécurité plate à ergots

| Code | Gencod | | L | Type packaging | |
|------------------|---------------|---------|-----|-------------------|---|
| Acier | | | | | |
| 0174403 | 3308181744032 | Z.BLANC | 450 | Brochable gencodé | 1 |
| Aluminium | | | | | |
| 0312906 | 3308183129066 | | 450 | Brochable gencodé | 1 |
| 0312926 | 3308183129264 | | 450 | Brochable gencodé | 1 |

Composition

- 1 barre de sécurité L450 mm
- 2 supports simples
- 2 supports antisoulèvement
- Visserie

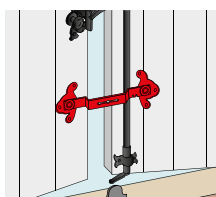
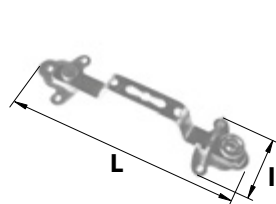

Entrebâilleur de volet

| Code | Gencod | | L | I | Type packaging | |
|---------|---------------|---------|-----|----|-------------------|---|
| 0700104 | 3308180040555 | | 285 | 83 | Brochable gencodé | 1 |
| 0700103 | 3308187001030 | Z.BLANC | 285 | 83 | Brochable gencodé | 1 |
| 0942703 | 3308189427036 | Z.BLANC | 285 | 83 | | 5 |



L'EXTÉRIEUR DE L'HABITAT

LES PERSIENNES

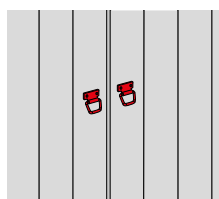
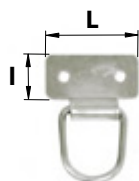

Anneau de tirage (x2)

| Code | Gencod | | L | I | Type packaging | |
|---------|---------------|---------|----|----|-------------------|---|
| 0952303 | 3308189523035 | Z.BLANC | 40 | 20 | Brochable gencodé | 1 |



Modèle gauche

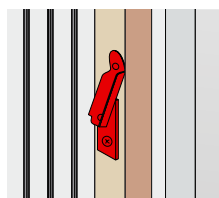

Arrêt de persienne à visser

| Code | Gencod | | L | I | H | Ep. | Type packaging | | |
|-------------------------------|---------------|---------|----|----|----|-----|-------------------|----|--|
| Modèle droite | | | | | | | | | |
| 0382703 | 3308183827030 | Z.BLANC | 90 | 20 | 60 | 3 | Vrac gencodé | 10 | |
| Modèle gauche | | | | | | | | | |
| 0382603 | 3308183826033 | Z.BLANC | 90 | 20 | 60 | 3 | Vrac gencodé | 10 | |
| Modèle droite + gauche | | | | | | | | | |
| 0701503 | 3308187015037 | Z.BLANC | 90 | 20 | 60 | 3 | Brochable gencodé | 1 | |

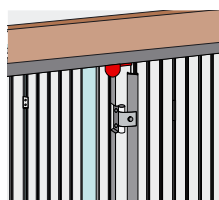

Butée de persienne à visser

| Code | Gencod | | L | I | H | Ep. | Type packaging | | |
|--------------------|---------------|---------|----|------|----|-----|-------------------|----|--|
| Modèle haut | | | | | | | | | |
| 538071 | 3221685380714 | | 30 | 23 | 27 | 2,5 | Vrac gencodé | 10 | |
| 538070 | 3479045380700 | Z.BLANC | 30 | 23 | 27 | 2,5 | Vrac gencodé | 10 | |
| 0961603 | 3308189616034 | Z.BLANC | 30 | 20 | 31 | 2,5 | Brochable gencodé | 1 | |
| Modèle bas | | | | | | | | | |
| 538081 | 3479045380816 | | 30 | 30 | 30 | 2,5 | Vrac gencodé | 10 | |
| 538080 | 3479045380809 | Z.BLANC | 30 | 30 | 30 | 2,5 | Vrac gencodé | 10 | |
| 538090 | 3479045380908 | Z.BLANC | 30 | 23 | 36 | 2,5 | Vrac gencodé | 10 | |
| 0961503 | 3308189615037 | Z.BLANC | 30 | 30,5 | 30 | 2,5 | Brochable gencodé | 1 | |

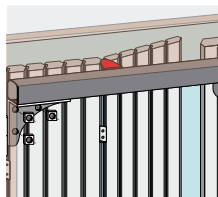
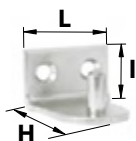

Crochet de rappel

| Code | Gencod | | L | I | H | Ep. | Type packaging | |
|---------|---------------|---------|----|----|----|-----|-------------------|---|
| 0962803 | 3308189628037 | Z.BLANC | 30 | 20 | 31 | 2,5 | Brochable gencodé | 1 |

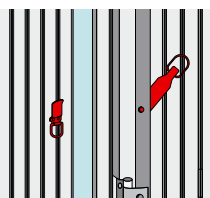
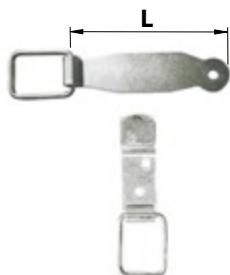

Loquet droit + support

| Code | Gencod | | L | Ep. | Type packaging | |
|---------|---------------|---------|----|-----|-------------------|---|
| 0957303 | 3308189573030 | Z.BLANC | 98 | 2,5 | Brochable gencodé | 1 |

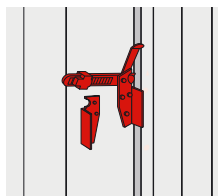

Loquet de persienne + support

| Code | Gencod | | L | Ep. | Type packaging | |
|---------|---------------|------|-----|-----|-------------------|---|
| 0963916 | 3308189639163 | GRIS | 201 | 2,5 | Brochable gencodé | 1 |

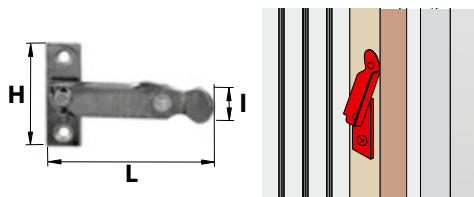

Modèle droite

Arrêt de persienne inox à visser + butée

| Code | Gencod | | L | I | H | Ep. | Type packaging | |
|----------------------|---------------|------|-------|----|----|-----|----------------|---|
| Modèle droite | | | | | | | | |
| 0960500 | 3308189605007 | 304L | 113,5 | 21 | 62 | 2 | Vrac gencodé | 1 |
| Modèle gauche | | | | | | | | |
| 0960600 | 3308189606004 | 304L | 113,5 | 21 | 62 | 2 | Vrac gencodé | 1 |

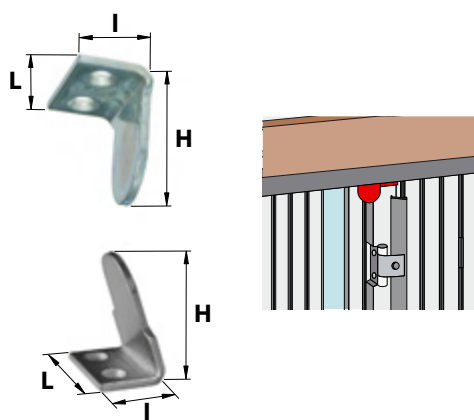

Butée de persienne inox à visser

| Code | Gencod | | L | I | H | Ep. | Type packaging | |
|--------------------|---------------|------|----|----|------|-----|-------------------|---|
| Modèle haut | | | | | | | | |
| 0962703 | 3308189627030 | 304L | 30 | 20 | 30,5 | 2 | Brochable gencodé | 1 |
| Modèle bas | | | | | | | | |
| 0961403 | 3308189614030 | 304L | 30 | 20 | 40 | 2 | Brochable gencodé | 1 |

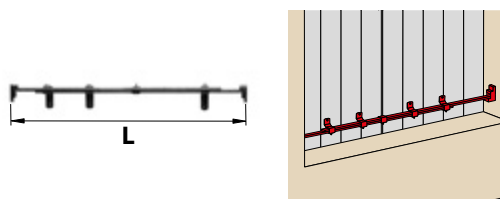

Barre de sécurité persienne recoupable

| Code | Gencod | | L | Type packaging | |
|---------|---------------|---------|------|-------------------|---|
| 0704203 | 3308187042033 | Z.BLANC | 1600 | Brochable gencodé | 1 |



L'EXTÉRIEUR DE L'HABITAT

LE VOLET ROULANT

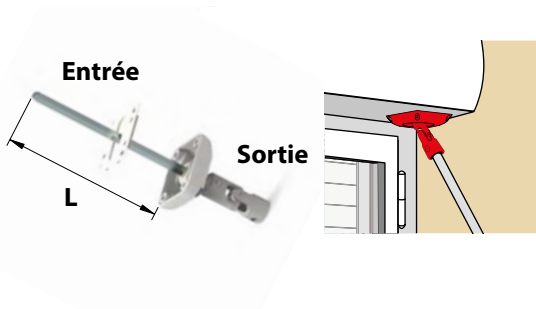

Sortie de caisson à 45°

| Code | Gencod | | L | Entrée | Sortie | Type packaging | |
|---------|---------------|----------------------|-----|--------|--------|-------------------|---|
| 0840900 | 3308188409002 | <input type="text"/> | 315 | ● 7 | ● 12 | Brochable gencodé | 1 |

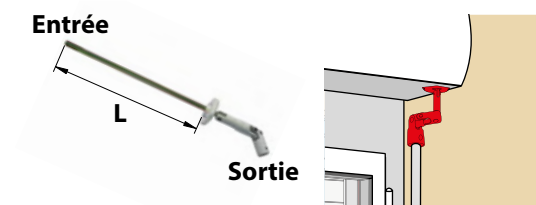

Sortie de caisson déportée

| Code | Gencod | | L | Entrée | Sortie | Type packaging | |
|---------|---------------|----------------------|-----|--------|--------|-------------------|---|
| 0841200 | 3308188412002 | <input type="text"/> | 210 | ● 7 | ● 12 | Brochable gencodé | 1 |

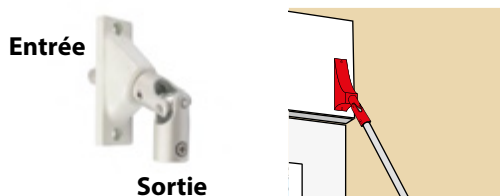

Sortie de caisson treuil à 90° + double cadran

| Code | Gencod | | Entrée | Sortie | Type packaging | |
|---------|---------------|----------------------|--------|--------|-------------------|---|
| 0841300 | 3308188413009 | <input type="text"/> | ● 7 | ● 12 | Brochable gencodé | 1 |

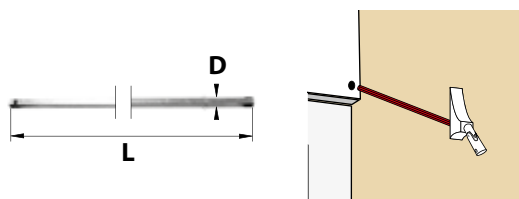

Tige passe-caisson recoupable

| Code | Gencod | | L | D | Type packaging | |
|---------|---------------|---------|-----|-----|----------------|---|
| 0840700 | 3308188407008 | Z.BLANC | 300 | ● 7 | Vrac gencodé | 1 |

Entrée



Sortie

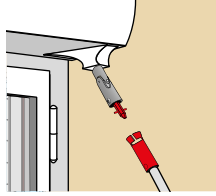

Kit manivelle décrochant

| Code | Gencod | | Entrée | Sortie | Type packaging | |
|---------|---------------|----------------------|--------|--------|-------------------|---|
| 0851500 | 3308188515000 | <input type="text"/> | ● 10 | ● 12 | Brochable gencodé | 1 |



Sortie

Entrée

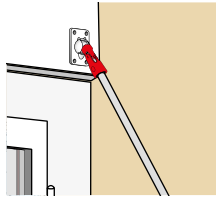

Genouillère acier chrome

| Code | Gencod | | Entrée | Sortie | Type packaging | |
|---------|---------------|--------|--------|--------|-------------------|---|
| 0842200 | 3308188422001 | CHROME | ● 7 | ● 12 | Brochable gencodé | 1 |
| 0842800 | 3308188428003 | CHROME | ● 10 | ● 12 | Brochable gencodé | 1 |
| 0842400 | 3308188424005 | CHROME | ● 10 | ● 10 | Brochable gencodé | 1 |
| 0842600 | 3308188426009 | CHROME | ● 12 | ● 12 | Brochable gencodé | 1 |



Sortie

Entrée

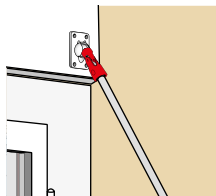

Genouillère acier laqué

| Code | Gencod | | Entrée | Sortie | Type packaging | |
|---------|---------------|----------------------|--------|--------|-------------------|---|
| 0877600 | 3308188776005 | <input type="text"/> | ● 7 | ● 12 | Brochable gencodé | 1 |
| 0878100 | 3308188781009 | <input type="text"/> | ● 10 | ● 12 | Brochable gencodé | 1 |
| 0877700 | 3308188777002 | <input type="text"/> | ● 10 | ● 10 | Brochable gencodé | 1 |
| 0877900 | 3308188779006 | <input type="text"/> | ● 12 | ● 12 | Brochable gencodé | 1 |

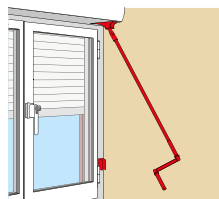
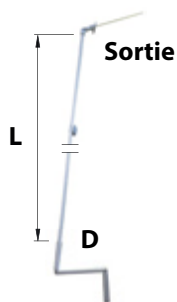

Kit manivelle complet classic

| Code | Gencod | | Sortie | D | L | Type packaging | |
|---------|---------------|----------------------|--------|------|------|----------------|---|
| 0843500 | 3308188435001 | <input type="text"/> | ● 7 | ● 12 | 1100 | Vrac gencodé | 1 |
| 0963800 | 3308189638005 | <input type="text"/> | ● 10 | ● 12 | 1100 | Vrac gencodé | 1 |

Composition
 1 sortie de caisson
 1 tringle
 1 poignée manivelle
 1 bloqueur de manivelle
 Visserie

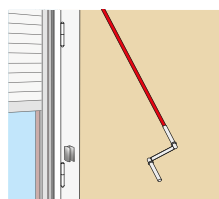

Tringle manivelle

| Code | Gencod | | D | L | Type packaging | |
|---------|---------------|----------------------|------|------|----------------|---|
| 0843700 | 3308188437005 | <input type="text"/> | ● 12 | 900 | Vrac gencodé | 1 |
| 0843600 | 3308188436008 | <input type="text"/> | ● 12 | 1100 | Vrac gencodé | 1 |

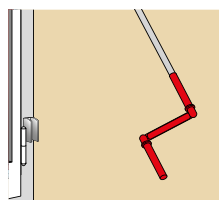

Poignée de manivelle pour tringle Ø12 mm

| Code | Gencod | | Type packaging | |
|---------|---------------|----------------------|-------------------|---|
| 0843200 | 3308188432000 | <input type="text"/> | Brochable gencodé | 1 |

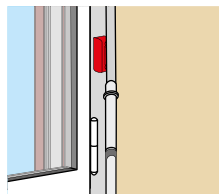

Bloqueur de manivelle magnétique

| Code | Gencod | | Type packaging | |
|--|---------------|----------------------|-------------------|---|
| Pour manivelle acier ● 12 mm et ● 10 mm | | | | |
| 0844000 | 3308188440005 | <input type="text"/> | Brochable gencodé | 1 |

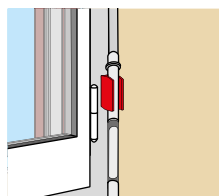

Bloqueur de manivelle design

| Code | Gencod | | Type packaging | |
|-------------------------------------|---------------|----------------------|-------------------|---|
| Pour manivelle acier ● 12 mm | | | | |
| 0841100 | 3308188411005 | <input type="text"/> | Brochable gencodé | 1 |

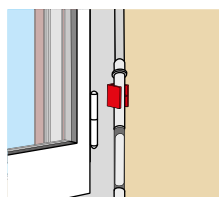

Bloqueur de manivelle classic

| Code | Gencod | | Type packaging | |
|-------------------------------------|---------------|----------------------|-------------------|---|
| Pour manivelle acier ● 12 mm | | | | |
| 0844100 | 3308188441002 | <input type="text"/> | Brochable gencodé | 1 |

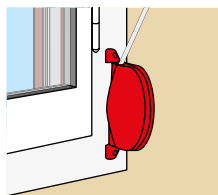

Enrouleur sous carter pivotant pour sangle 14/15 mm

| Code | Gencod | | Type packaging | |
|---------|---------------|----------------------|----------------|---|
| 0846200 | 3308188462007 | <input type="text"/> | Vrac gencodé | 1 |

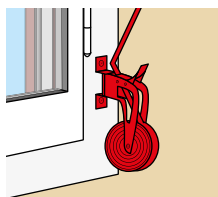

Enrouleur pivotant pour sangle 20/22 mm

| Code | Gencod | | Type packaging | |
|---------|---------------|---------|----------------|---|
| 0846500 | 3308188465008 | Z.BLANC | Vrac gencodé | 1 |

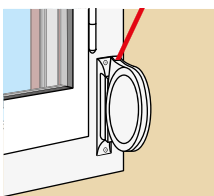

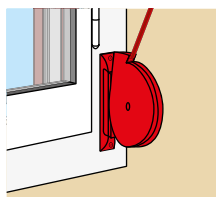

Sangle

| Code | Gencod | | L | Type packaging | |
|------------------|---------------|----------------------|------|-------------------|----|
| 114/15 mm | | | | | |
| 0850500 | 3308188505001 | <input type="text"/> | 6000 | Brochable gencodé | 1 |
| 0933400 | 3308189334006 | <input type="text"/> | 6000 | | 10 |
| 120/22 mm | | | | | |
| 0851000 | 3308188510005 | <input type="text"/> | 5500 | Brochable gencodé | 1 |





**Enrouleur pivotant réglable
+ sangle 14/15 mm L5,8m**

| Code | Gencod |  | Type packaging |  |
|---------|---------------|---|-------------------|---|
| 0957100 | 3308189571005 | <input type="checkbox"/> | Brochable gencodé | 1 |
| 0845100 | 3308188451001 | <input type="checkbox"/> | Brochable gencodé | 1 |

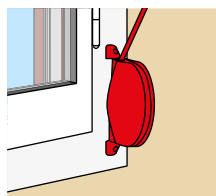
Mise en tension et changement de la sangle possible sans démonter le boîtier.



Enrouleur sous carter pivotant + sangle 14/15 mm L6m

| Code | Gencod |  | Type packaging |  |
|---------|---------------|---|---|---|
| 0957000 | 3308189570008 | <input type="checkbox"/> | Vrac gencodé | 1 |
| 0844800 | 3308188448001 | <input type="checkbox"/> | Brochable gencodé | 1 |
| 0933300 | 3308189333009 | <input type="checkbox"/> |  | 4 |

Accessoires volets roulants à sangle



14/15 mm



20/22 mm

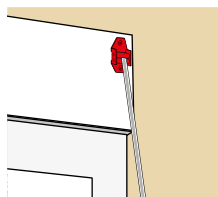

Guide-sangle classic

| Code | Gencod | | Type packaging | |
|---|---------------|--------------------------|-------------------|---|
| Pose horizontale pour sangle I14/15 mm | | | | |
| 0848700 | 3308188487000 | <input type="checkbox"/> | Brochable gencodé | 1 |
| Pose verticale pour sangle I20/22 mm | | | | |
| 0848600 | 3308188486003 | <input type="checkbox"/> | Brochable gencodé | 1 |



14/15 mm

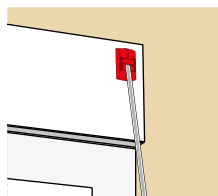

Guide-sangle design

| Code | Gencod | | Type packaging | |
|--|---------------|--------------------------|-------------------|---|
| Pose horizontale + fixations invisibles | | | | |
| 0849500 | 3308188495005 | <input type="checkbox"/> | Brochable gencodé | 1 |
| Pose verticale + fixations invisibles | | | | |
| 0849000 | 3308188490000 | <input type="checkbox"/> | Brochable gencodé | 1 |

Accessoires volets roulants à cordon

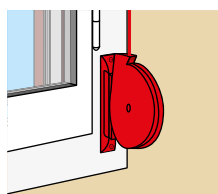

Enrouleur pivotant réglable à cordon

| Code | Gencod | | Type packaging | |
|---------|---------------|--------------------------|-------------------|---|
| 0956900 | 3308189569002 | <input type="checkbox"/> | Brochable gencodé | 1 |

Accessoires volets roulants à chaîne

Ø4,5 mm

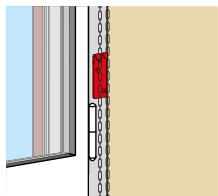

Arrêt de chaîne

| Code | Gencod | | Type packaging | |
|---------|---------------|---------|-------------------|---|
| 0851400 | 3308188514003 | Z.BLANC | Brochable gencodé | 1 |



14/22 mm

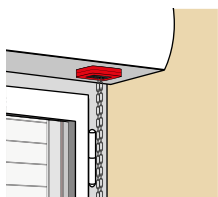

Guide STOPVENT chaîne ou sangle

| Code | Gencod | | Type packaging | |
|---------|---------------|--|-------------------|---|
| 0847500 | 3308188475007 | | Brochable gencodé | 1 |

Accessoires volets roulants à tirage direct

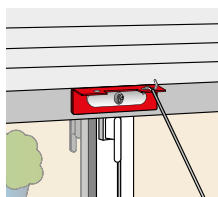
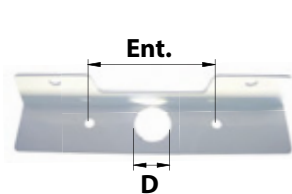

Poignée de tirage

| Code | Gencod | | D | Ent. | Type packaging | |
|---------|---------------|--|----|------|-------------------|---|
| 0851900 | 3308188519008 | | 25 | 90 | Brochable gencodé | 1 |

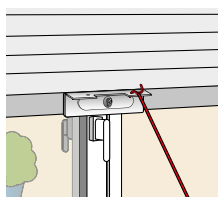

Bâton de tirage

| Code | Gencod | | L | Type packaging | |
|---------|---------------|--|------|-------------------|---|
| 0851800 | 3308188518001 | | 1000 | Brochable gencodé | 1 |

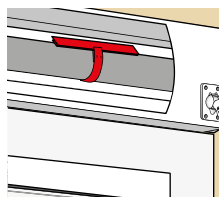
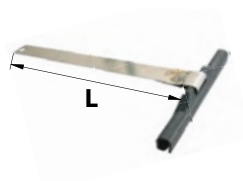

Attache souple lame épaisse (x2)

| Code | Gencod | | L | Type packaging | |
|------|--------|--|---|----------------|--|
|------|--------|--|---|----------------|--|

Pour tablier court

| | | | | | |
|---------|---------------|--|-----|-------------------|---|
| 0881200 | 3308188812000 | | 140 | Brochable gencodé | 1 |
|---------|---------------|--|-----|-------------------|---|

Pour tablier long

| | | | | | |
|---------|---------------|--|-----|-------------------|---|
| 0842000 | 3308188420007 | | 180 | Brochable gencodé | 1 |
|---------|---------------|--|-----|-------------------|---|

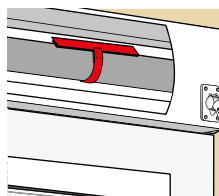
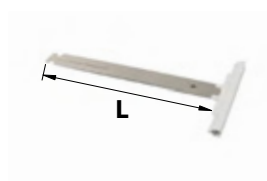

Attache souple lame souple (x2)

| Code | Gencod | | L | Type packaging | |
|------|--------|--|---|----------------|--|
|------|--------|--|---|----------------|--|

Pour tablier court

| | | | | | |
|---------|---------------|--|-----|-------------------|---|
| 0843950 | 3308188439504 | | 150 | Brochable gencodé | 1 |
|---------|---------------|--|-----|-------------------|---|

Pour tablier long

| | | | | | |
|---------|---------------|--|-----|-------------------|---|
| 0843980 | 3308188439801 | | 180 | Brochable gencodé | 1 |
|---------|---------------|--|-----|-------------------|---|

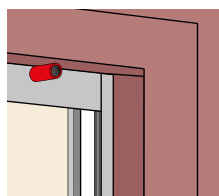
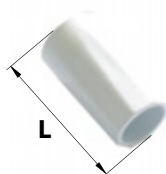

Butée de lame finale (x2)

| Code | Gencod | | L | Type packaging | |
|------|--------|--|---|----------------|--|
|------|--------|--|---|----------------|--|

| | | | | | |
|---------|---------------|--|----|-------------------|---|
| 0851300 | 3308188513006 | | 40 | Brochable gencodé | 1 |
|---------|---------------|--|----|-------------------|---|

| | | | | | |
|---------|---------------|--|----|-------------------|---|
| 0851200 | 3308188512009 | | 40 | Brochable gencodé | 1 |
|---------|---------------|--|----|-------------------|---|

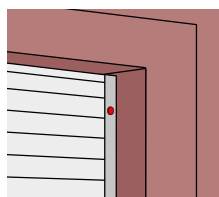
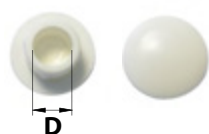

Bouchon de protection (x10)

| Code | Gencod | | D | Type packaging | |
|------|--------|--|---|----------------|--|
|------|--------|--|---|----------------|--|

| | | | | | |
|---------|---------------|--|----|-------------------|---|
| 0851700 | 3308188517004 | | 10 | Brochable gencodé | 1 |
|---------|---------------|--|----|-------------------|---|

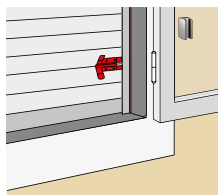

Verrou antisoulèvement (x2)

| Code | Gencod | | Type packaging | |
|---------|---------------|---------|-------------------|---|
| 1018302 | 3308180183023 | Z.BLANC | Brochable gencodé | 1 |

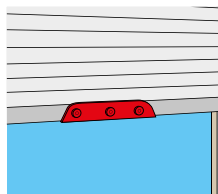

Barre de verrouillage volet roulant

| Code | Gencod | | Type packaging | |
|---------|---------------|--|-------------------|---|
| 0700426 | 3308187004260 | | Brochable gencodé | 1 |

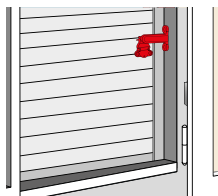

Kit verrouillage automatique volet roulant

| Code | Gencod | | Type packaging | |
|---------|---------------|--|-------------------|---|
| 0996500 | 3308189965002 | | Brochable gencodé | 1 |

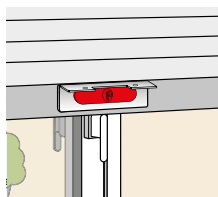

Serrure extraplate 3 clés

| Code | Gencod | | Type packaging | |
|---------|---------------|--|-------------------|---|
| 0851600 | 3308188516007 | | Brochable gencodé | 1 |